

Profili 2022/23

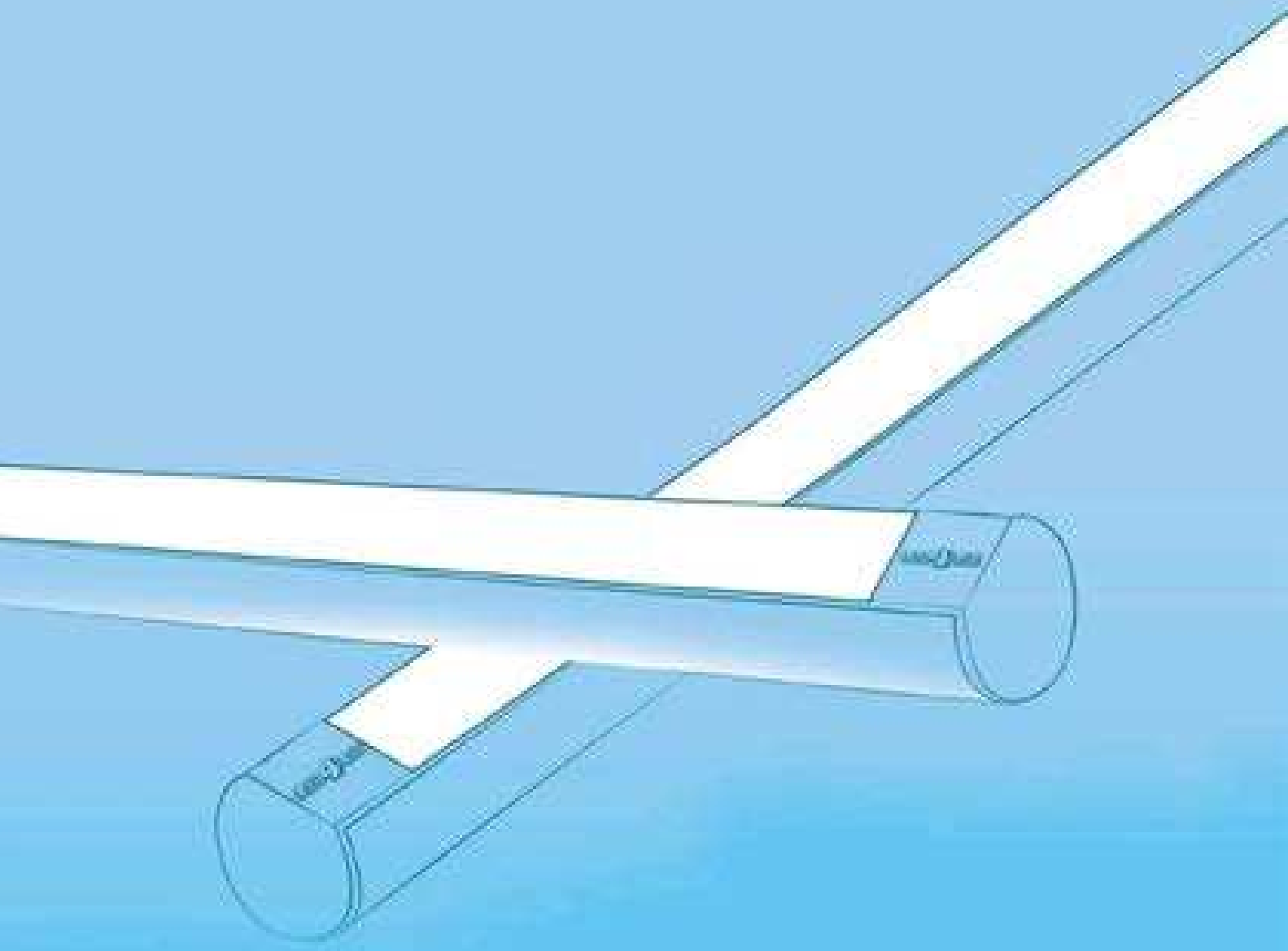



Profili per mobili - Cartongessi -
Sospensioni



A 74BAPL005
74BAPL006
Cilindro LED

B 74BAPL001
74BAPL1006

C 74BAPL005
74BAPL006
Cilindro LED
24CB11

H 74S1010
74BAPL002

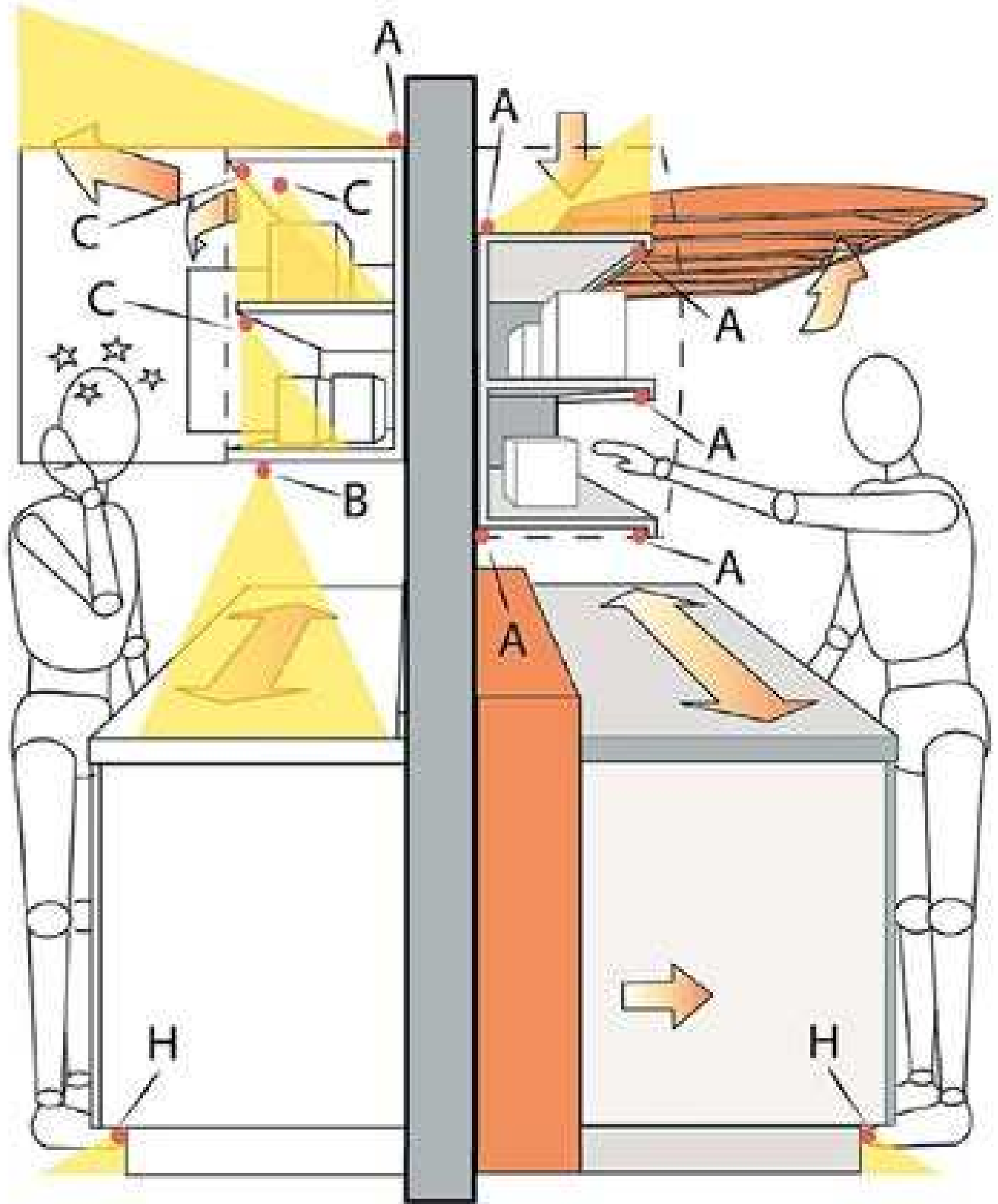

D Cilindro LED

E 74BAPL002
Cilindro LED

F 74S0808
74S1010
Cilindro LED

G 24DP07
24DP08

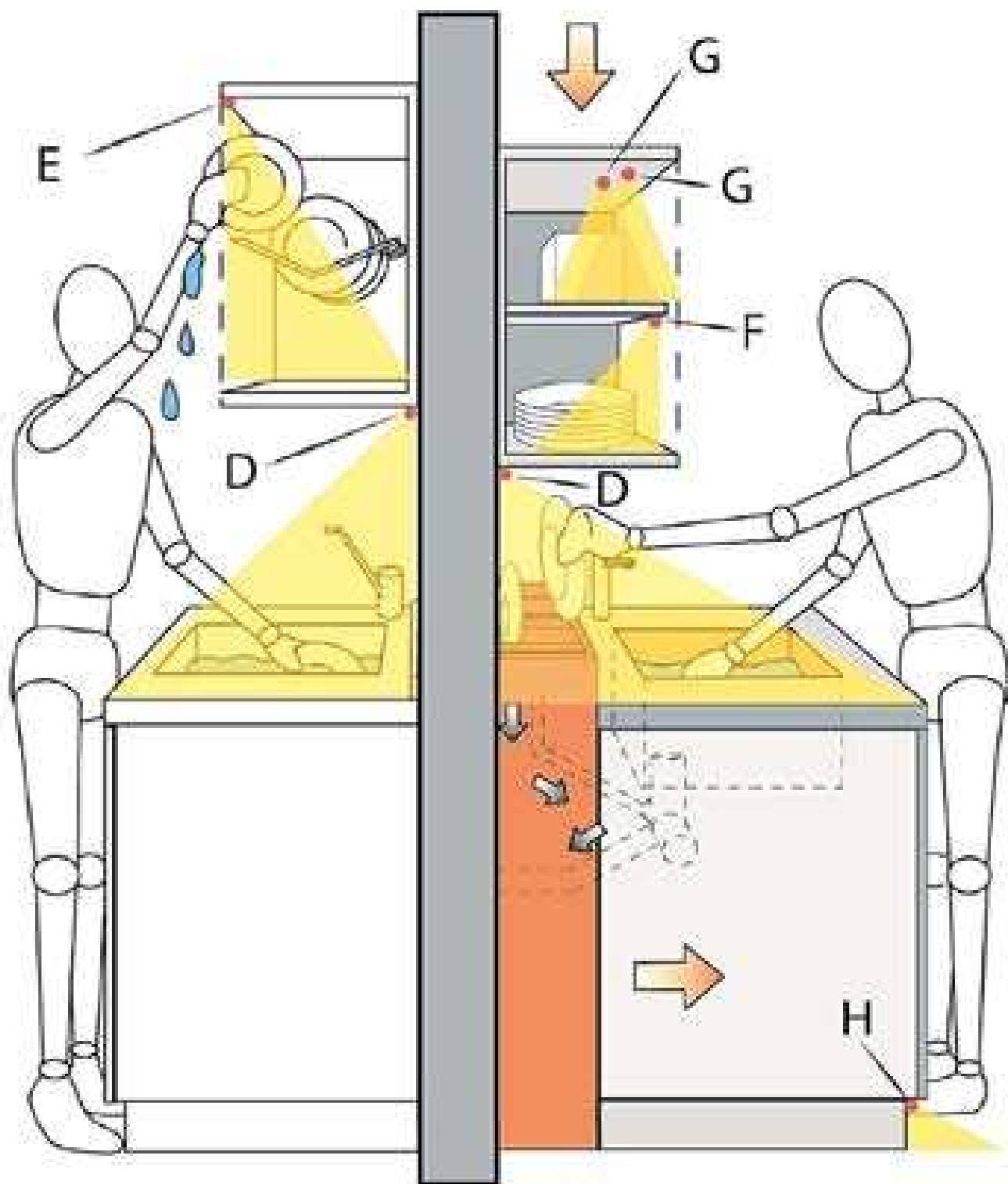

PROFILI PER STRIP 5mm

74S0808

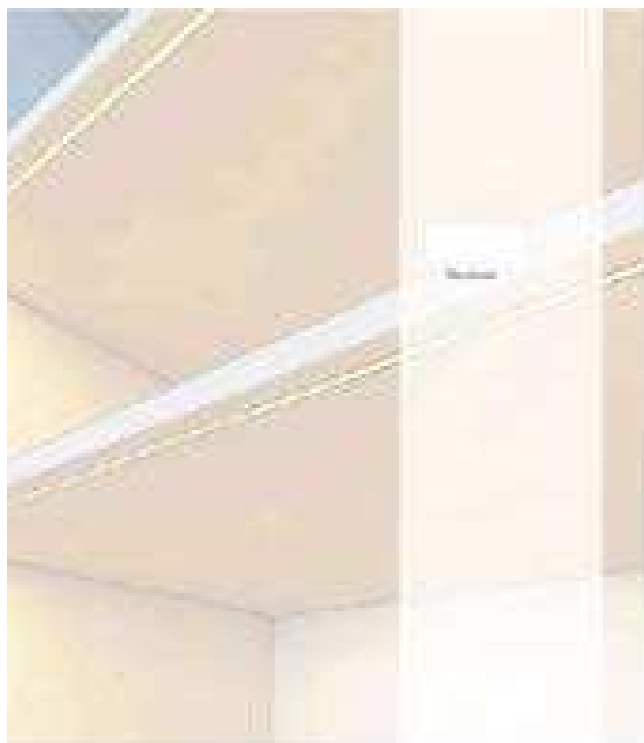

7450808PR1



7450808EC1

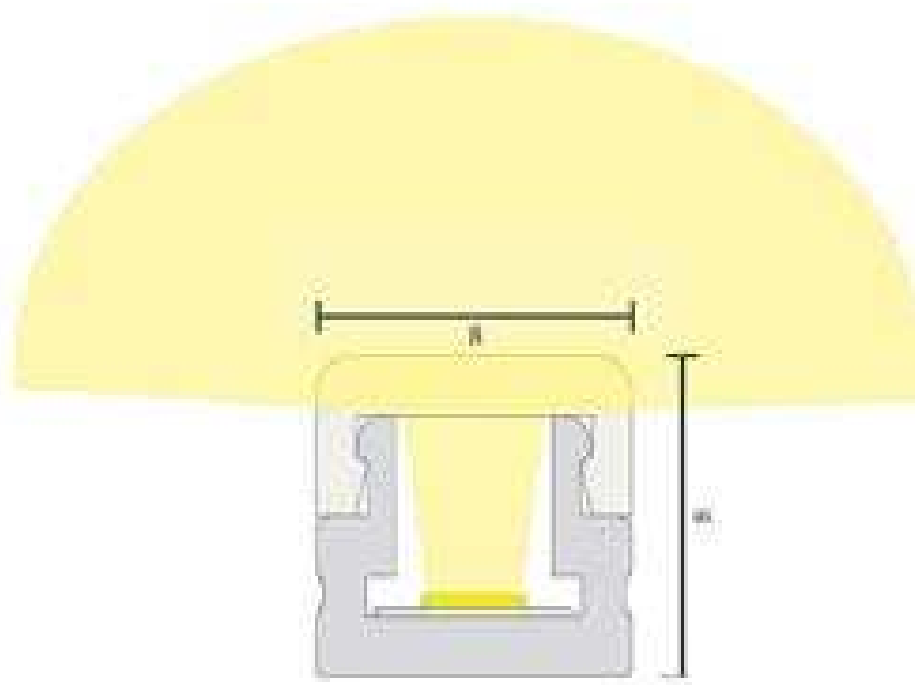

PROFILI PER STRIP 5mm

74S1010

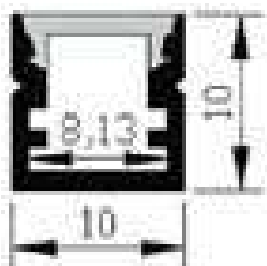
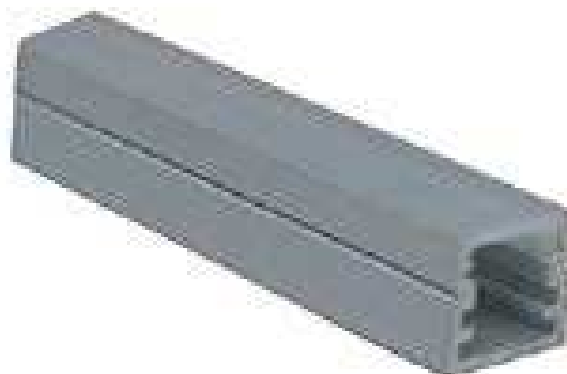

PROFILI PER MOBILIO

74TR1010

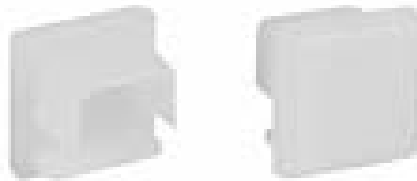
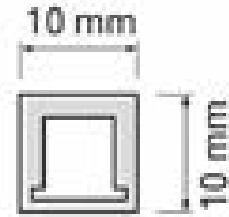

End caps



PROFILI PER MOBILIO

74TR1515

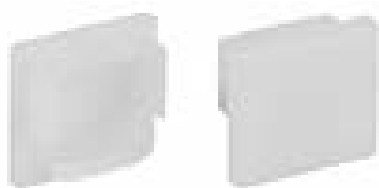
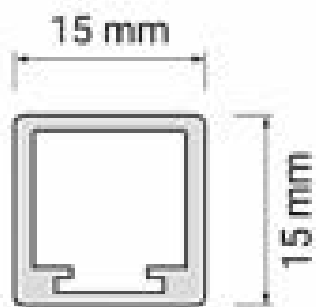

End caps



PROFILI PER MOBILIO

74HL067

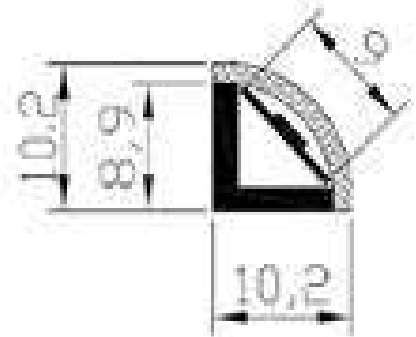
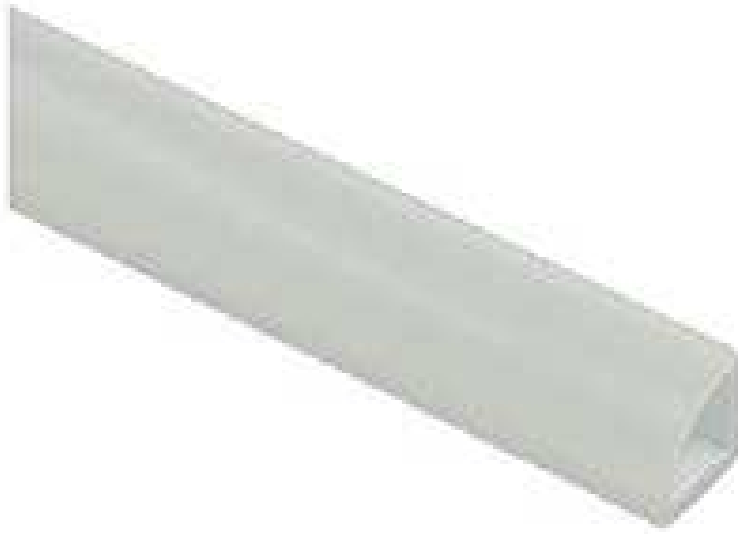

End Cap



Aluminum Profile



Mounting Clip (metal)



Waterproof Grade

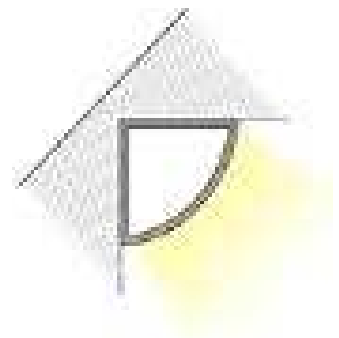

PROFILI PER MOBILIO

74HL070

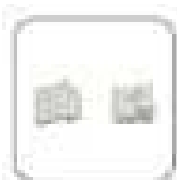
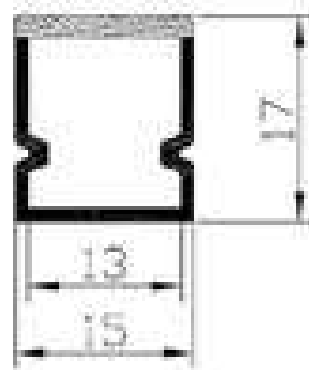

End Cap



Aluminum Profile



Mounting Clip (metal)



Waterproof Class

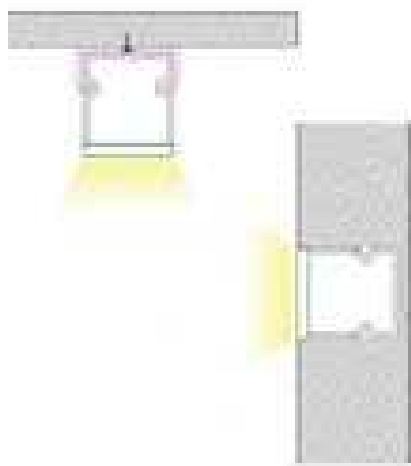

PROFILI PER MOBILIO

74SLASH8

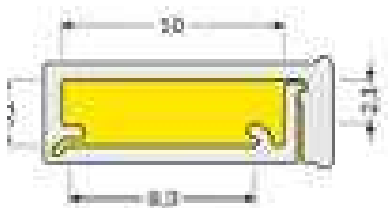
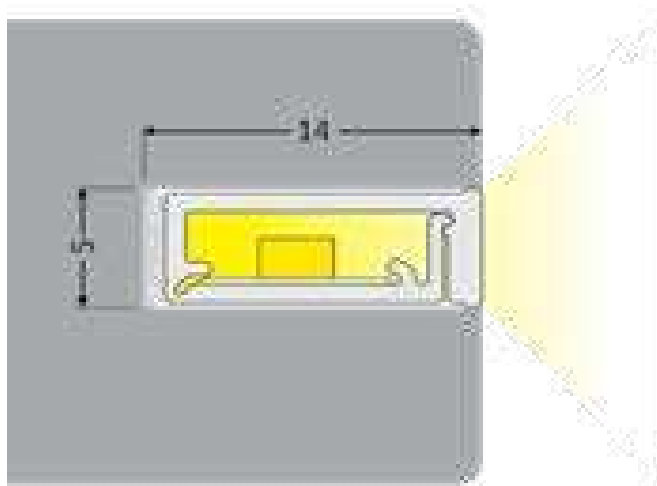
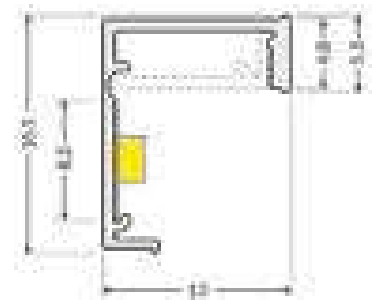

PROFILI PER MOBILIO

74BAPLO709



Accessori:

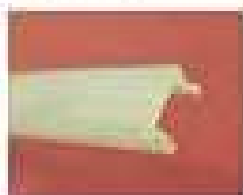

74BAPLO709O

Lente opale piatta. Lunghezza max 2,5 metri



74BAPLO709O60

Lente angolare 60°. Lunghezza max 2,5 metri



74BAPLO709DSC

Graffa in acciaio



74BAPLO709ECE

Tapco senza foro

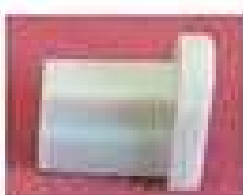

74BAPLO709EC

Tapco senza foro

PROFILI PER MOBILIO

74BAPL1006

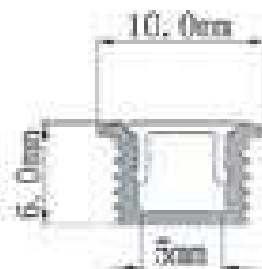
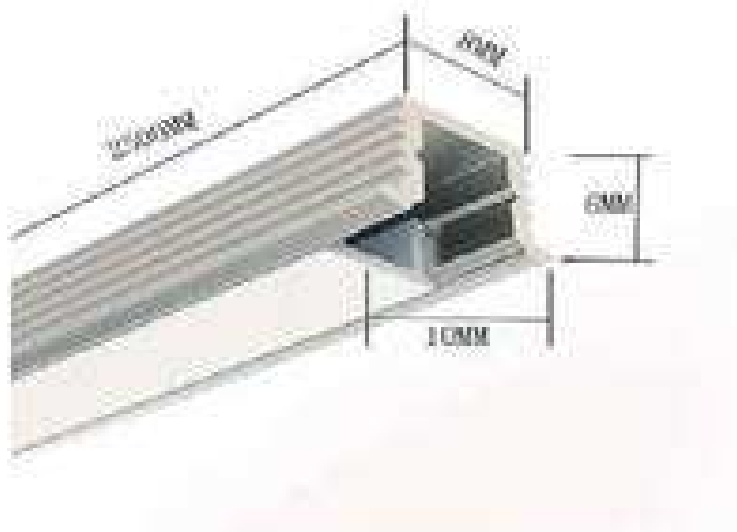

Accessori:



74BAPL1006O
Lente opale piatta. Lunghezza max 3,5 metri



74BAPL1006ECE
Tappo senza foro



74BAPL1006DSC
Graffa in acciaio

PROFILI PER MOBILIO

74BAPL001

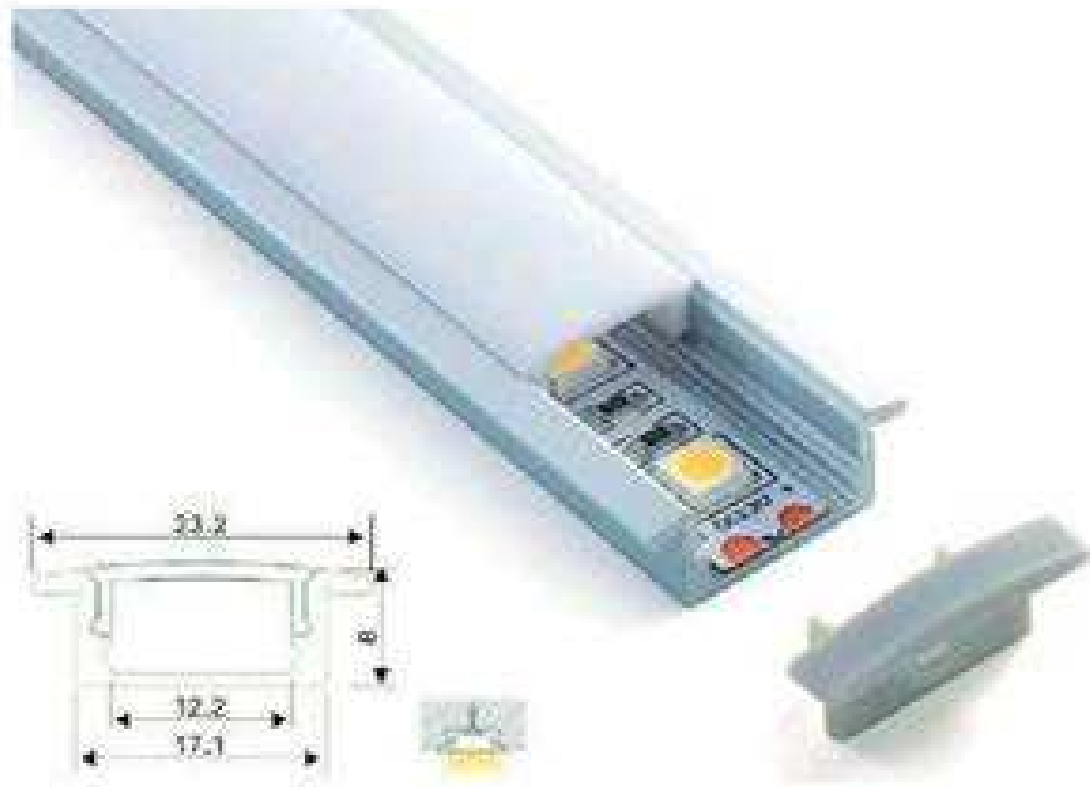

PROFILI PER MOBILIO

74BAPL002



PROFILI PER MOBILIO

74SLIM8

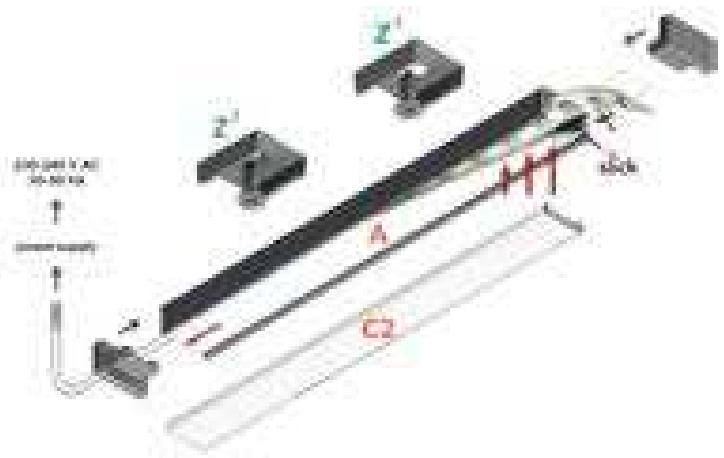
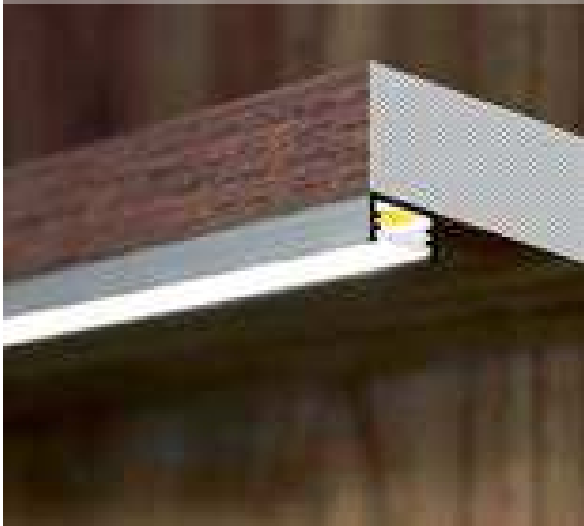

Z¹
Z flexible
mounting plate = 101
uchwyt Z sprężysty
= 101

Z²
cone Z flexible
mounting plate = 101
uchwyt Z sprężysty
cone = 101

<p>SLIM8 with cap material: ABS</p> <p>ABS 81180001 slim 81180001 slim 81180001 slim 81180001</p>	<p>SLIM8 with cap other hole material: ABS</p> <p>ABS 81180001 slim 81180001 slim 81180001 slim 81180001</p>	<p>SLIM8 connector 90 deg material: aluminum</p> <p>aluminum 81180001 slim 81180001 slim 81180001</p>
---	--	---



A
A slide diffuser = 94
slim A wysuwany = 94

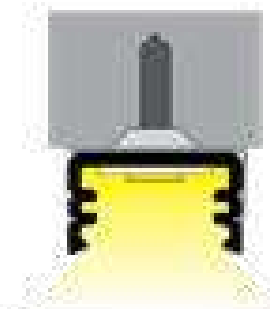

C2
C2 click diffuser = 95
slim C2 klik = 95



click

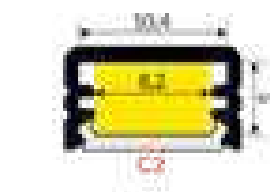

C2

PROFILI PER MOBILIO

74BEGTON12



S¹
S flexible mounting
plate > 98

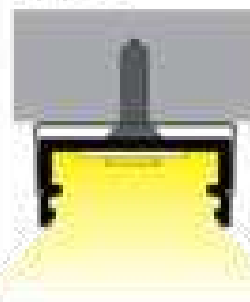

S¹
cone S flexible mounting
plate > 98

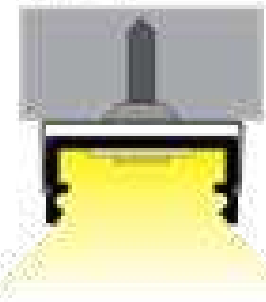

J
J slide diffuser > 97



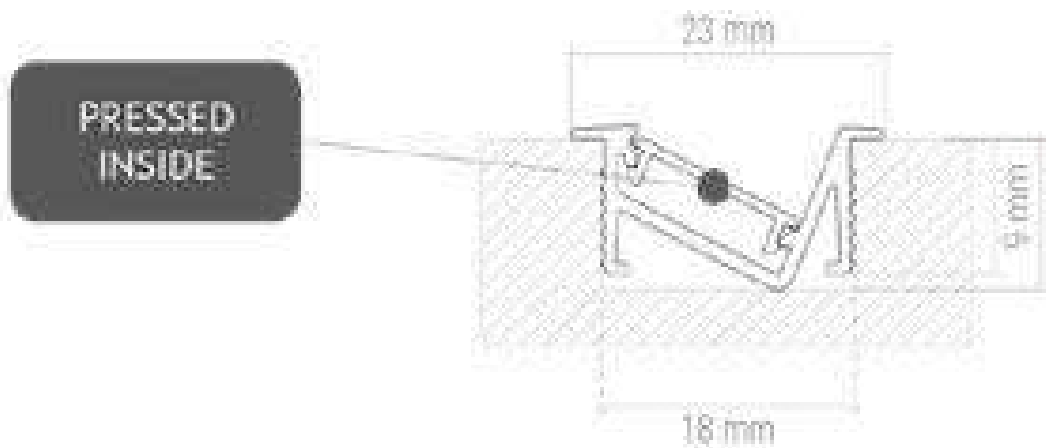

		Opal diffusor	End cap
White	2 m	PROFIL 74ZENOLINE-OP-3M-B	DPS-ZASL-74LINE-BC-01
Black	2 m	PROFIL 74ZENOLINE-OP-3M-C	DPS-ZASL-74LINE-CC-01
Aluminum	2 m	PROFIL 74ZENOLINE-OP-3M-W	DPS-ZASL-74LINE-CC-01

74RELINGSLIM



		Opal diffuser
Aluminium	2 m	PROF-REL-S-AL-OP-2M
	3 m	PROF-REL-S-AL-OP-3M
White	2 m	PROF-REL-S-BI-OP-2M
	3 m	PROF-REL-S-BI-OP-3M
Black	2 m	PROF-REL-S-CZ-OP-2M
	3 m	PROF-REL-S-CZ-OP-3M

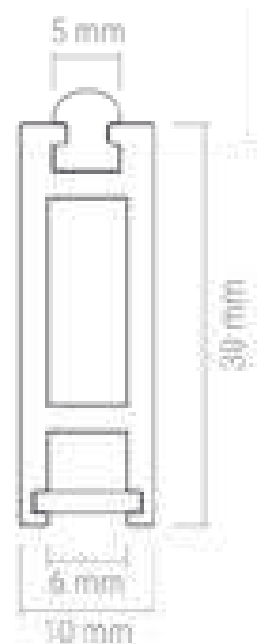

PROFILI PER MOBILIO

74DIAGONAL14

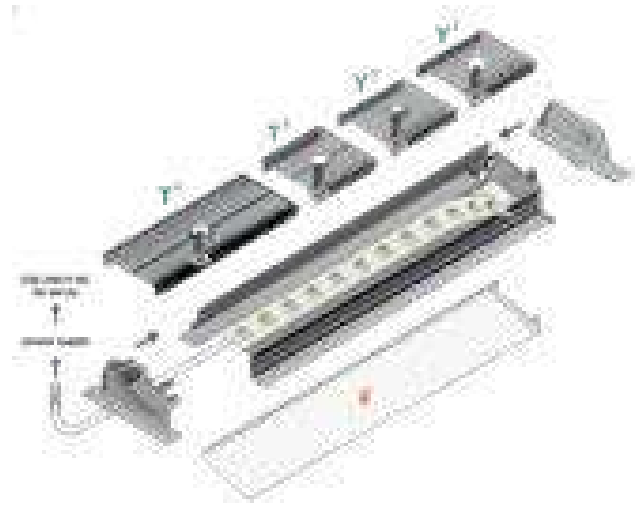

DIAGONAL14 end cap with hole
material: ABS



white
43999901

silver
43999903

black
43999902

EPFV
43999922

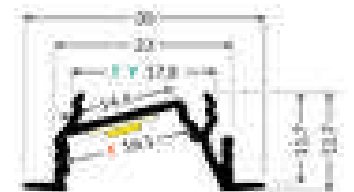

PROFILI PER MOBILIO

74GROOVE10

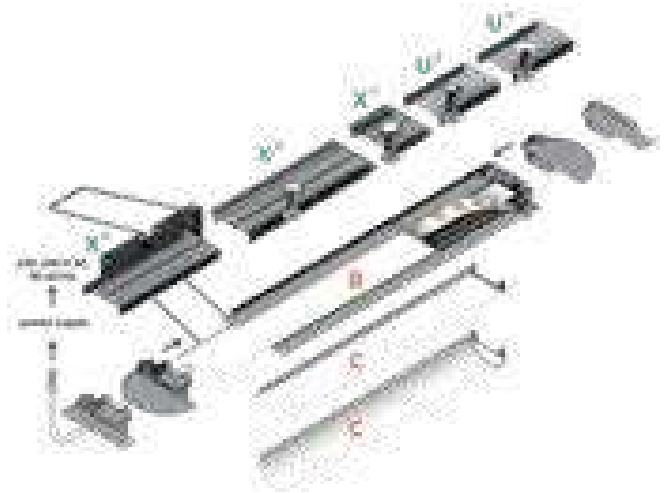

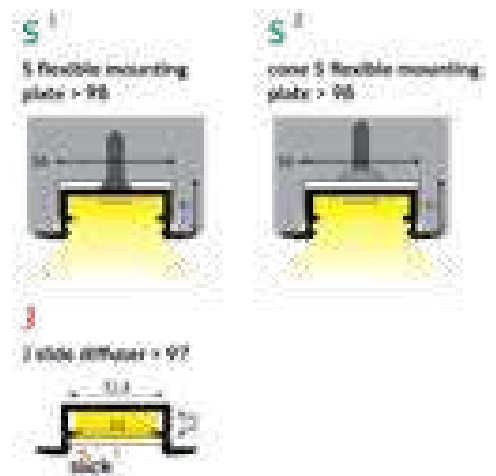
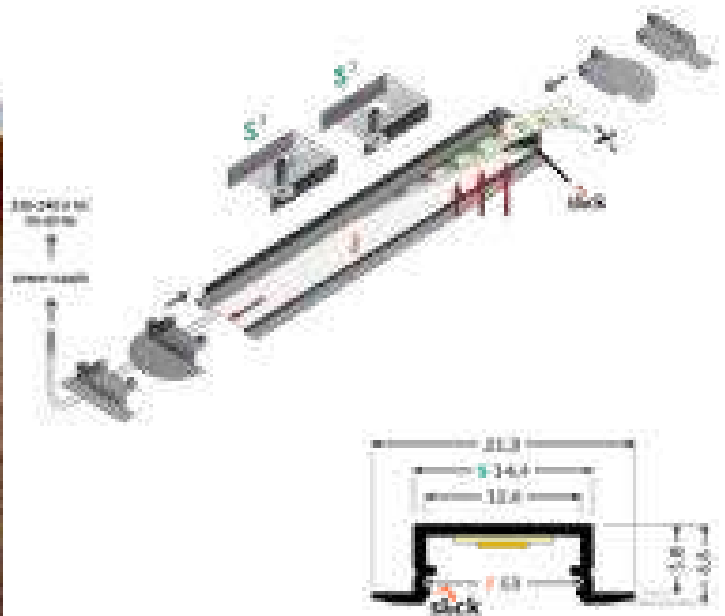

BE074C1 end cap
good with hole
material ABS



- white
CB070001
- silver
CB070004
- black
CB070001
- grey
CB070002

BE074C2 end cap
good 14 with hole
material ABS



- white
CB070001
- silver
CB070004
- black
CB070002
- grey
CB070002



PROFILI PER MOBILIO

74WIDE24

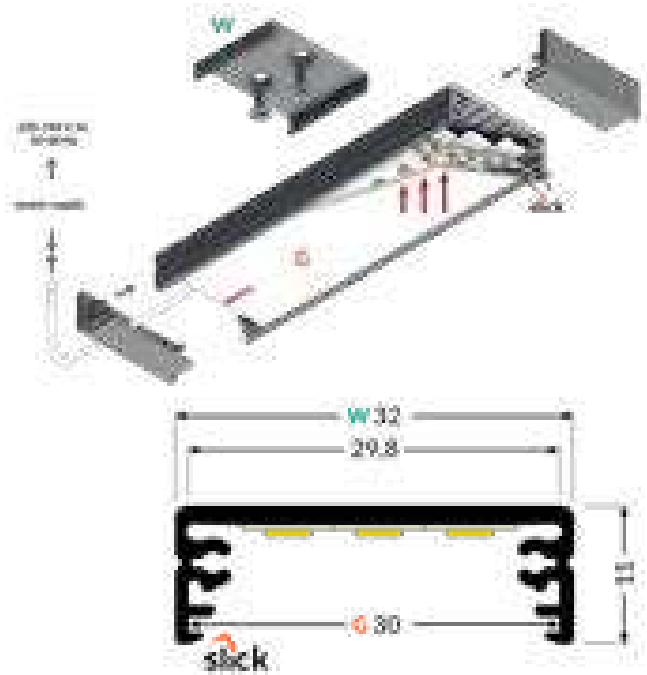

74WIDE24 end cap
material: ABS



- white
84040001
- silver
84040040
- black
84040002
- grey
84040003

74WIDE24 end cap with hole
material: ABS



- white
84100001
- silver
84100040
- black
84100002
- grey
84100003

W

cone W flexible mounting
plate > 100
uchwył W sprężyste
cone > 100

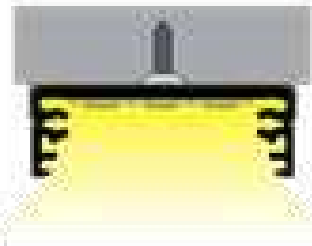

G

G slide diffuser > 97
klosz G wysuwany > 97



PROFILI PER MOBILIO

74BAPLO14



End cap with hole
End cap without hole

74BAPLO14EC1
74BAPLO14EC0



Aluminum profile

74BAPLO14PR



PMMA opal matte cover
PMMA semi-clear cover
PC diffused cover

74BAPLO130
74BAPLO13ST
74BAPLO13D



Mounting clip (metal)

74BAPLO14MCM

74BAPL013



End cap with hole
End cap without hole

74BAPL013EC1
74BAPL013EC0



Aluminum profile
74BAPL013PR



PMMA opal matte cover
PMMA semi-clear cover
PC diffused cover

74BAPL013O
74BAPL013ST
74BAPL013D

PROFILI PER MOBILIO

74BAPL005



PROFILI PER MOBILIO

74BAPL006



End cap with hole
End cap without hole

74BAPL006EC1
74BAPL006EC0



Aluminum profile

74BAPL005PR



PMMA opal matte cover
PMMA semi-clear cover
PC diffused cover

74BAPL0060
74BAPL006ST
74BAPL006D



Mounting clip (metal)

74BAPL005MCM
74BAPL005MCM



Mounting clip (PC)

74BAPL005PR



PROFILI PER MOBILIO

74BAPLCABI12

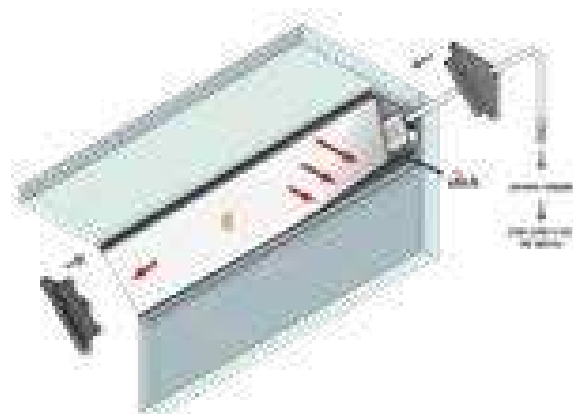

CAB12 end cap material ABS

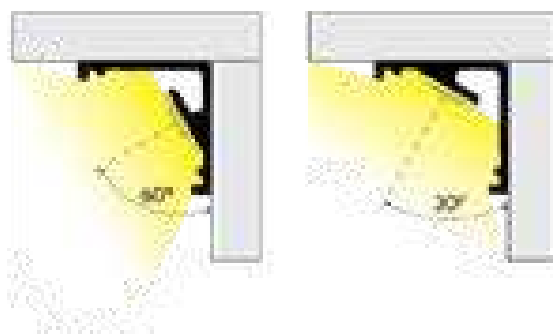

E
E slide diffuser = 96

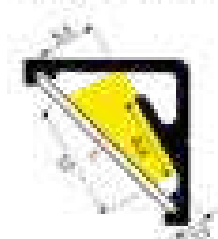

PROFILI PER MOBILIO

74BAPL016/EF

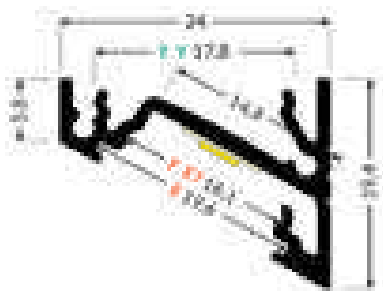
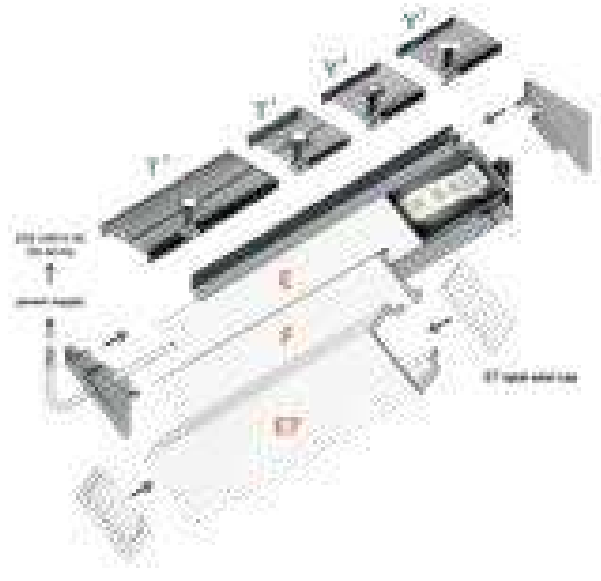

PROFILI PER MOBILIO

74BAPL006 LENT

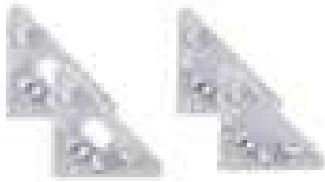
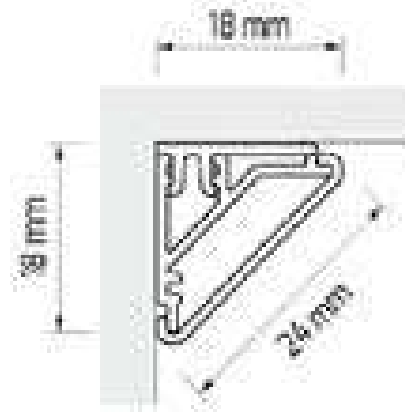

End clips



Mounting clips



PROFILI PER MOBILIO

74BAPL016

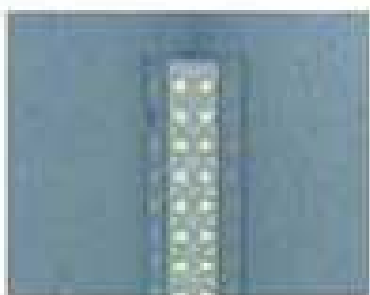
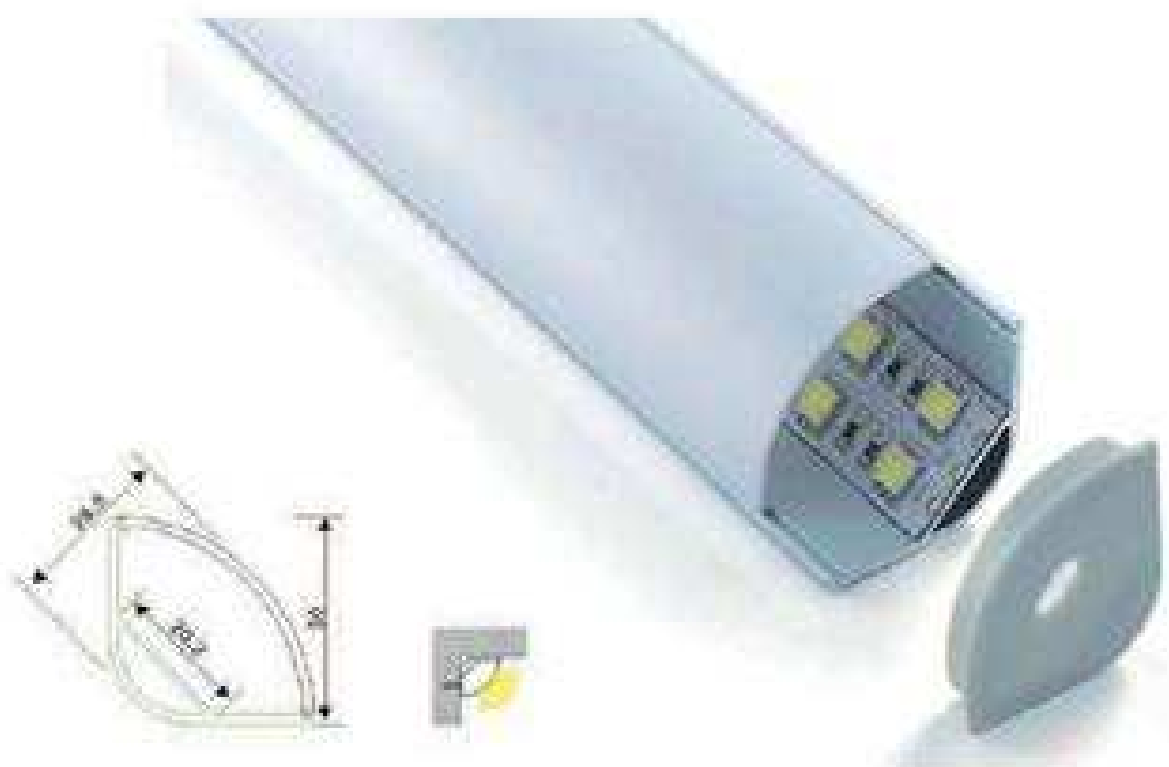

PROFILI PER MOBILIO

74BAPL015

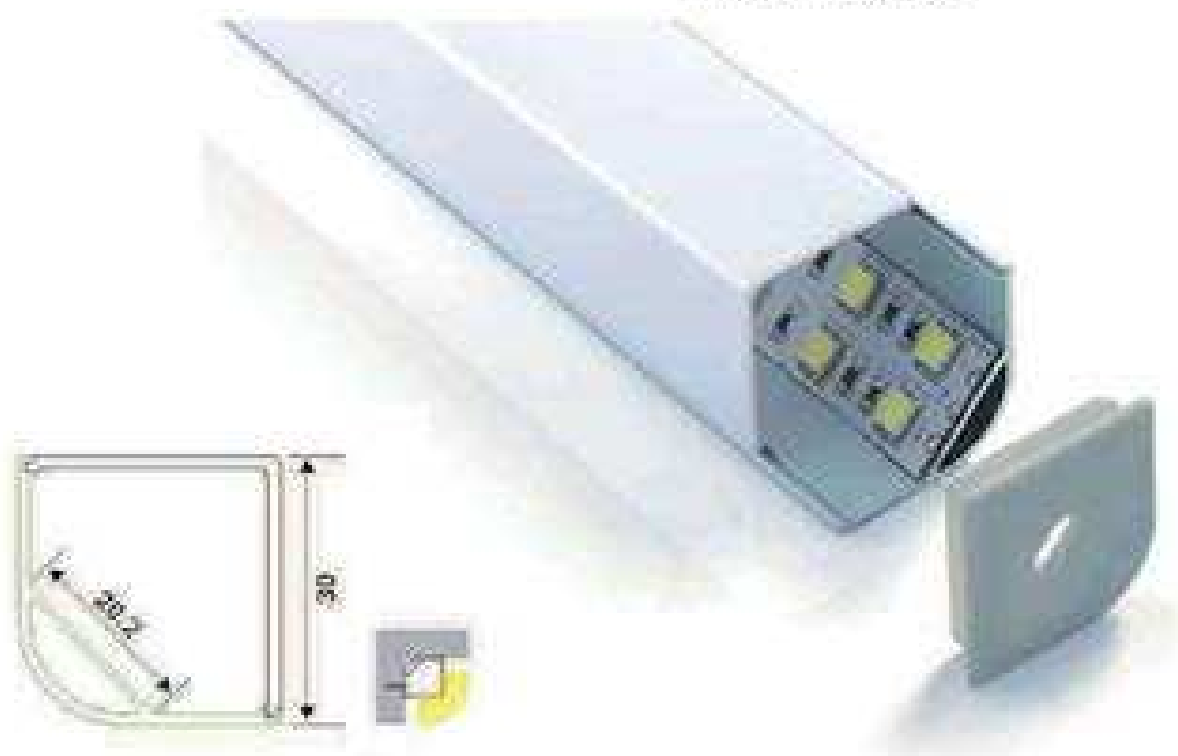

End cap with hole
End cap without hole

74BAPL015EC1
74BAPL015EC0



Aluminum profile

74BAPL015PR



PMMA opal matte cover
PMMA semi-clear cover

74BAPL015O
74BAPL015ST



Mounting clip (metal)

74BAPL015MCM

PROFILI PER MOBILIO

74ALP039-30

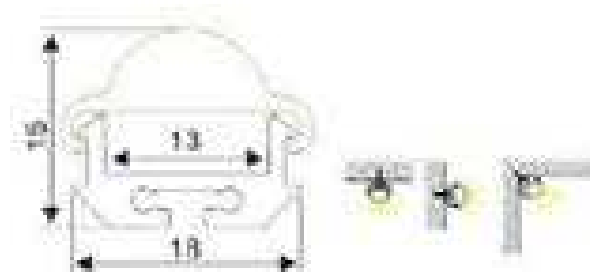

Aluminum profile



30 degree led
PMMA semi clear



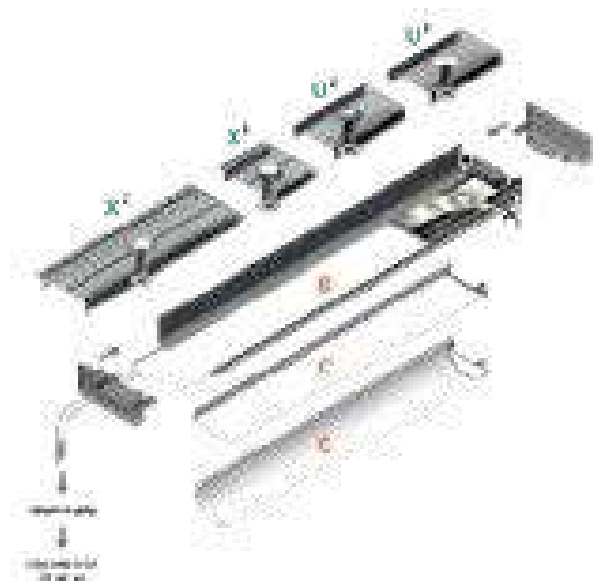

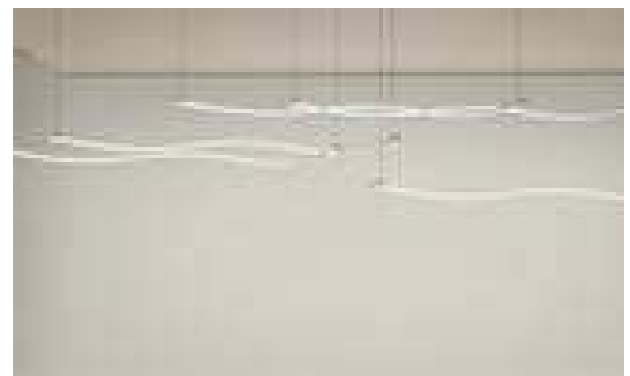
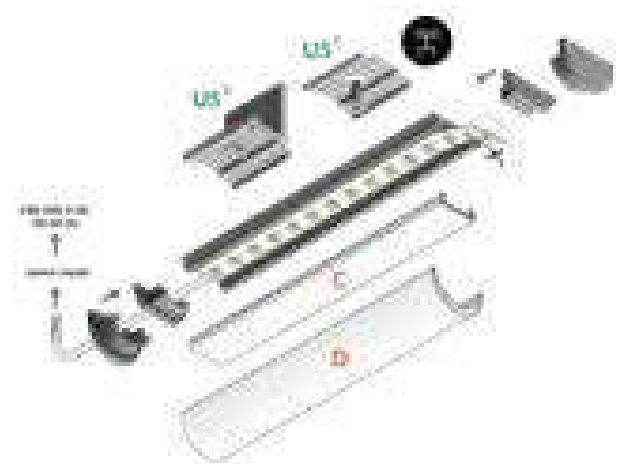

PROFILI PER MOBILIO

74ARC12



ARC12 end cap material: ABS	ARC12 D end cap material: ABS
   	   
white E2140004 silver E2140040 black E2140000 grey E2140010	white E2140001 silver E2140040 black E2140000 grey E2140010

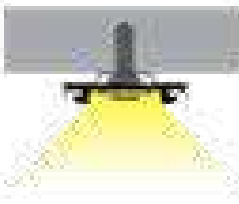
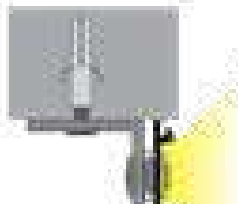

US ¹ US mounting plate corner = 90°	US ¹ US mounting plate side = 90°
	
C C click diffuser = 94°	
	
D D click diffuser = 90°	
	

PROFILI PER MOBILIO

74FRONTLINE-P

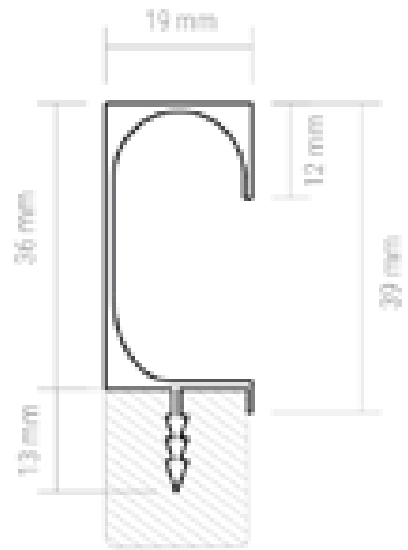

74FRONTLINE-P-AN



74FRONTLINE-P-BL

PROFILI PER MOBILIO

74HL044C

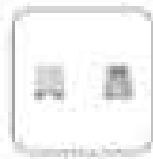
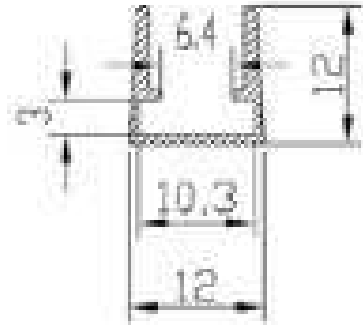

End Cap



Al Profile (Ano) Cap



Al Profile (Black) Cap

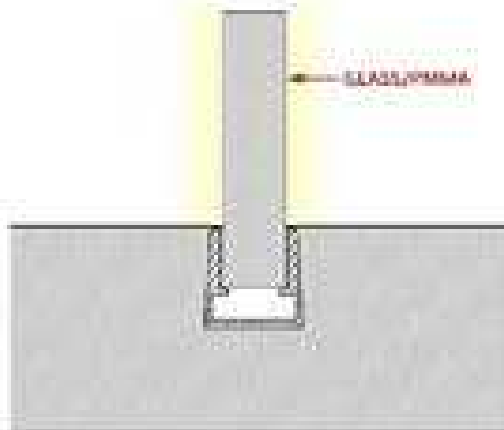

PROFILI PER MOBILIO

74HL044A



End Cap



Alu Profile End Cap



Alu Profile (Back)

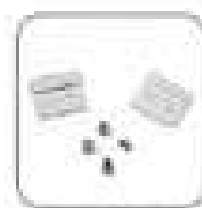

Mounting Clip (metal)

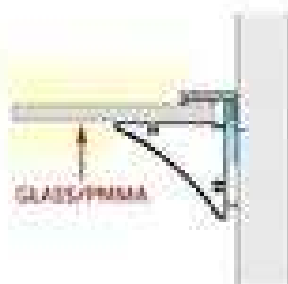

PROFILI PER MOBILIO

74HL044

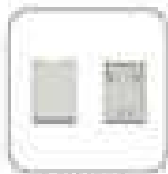
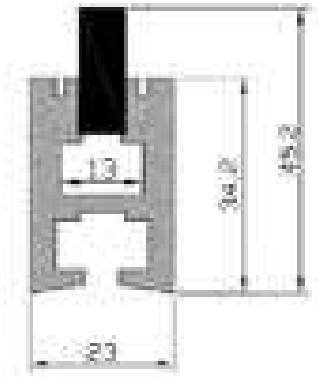

End Cap



Alu Profile+End Cap



Alu Profile (Back)



Mounting Screw

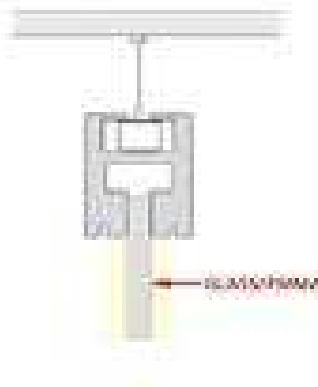

PROFILI PER MOBILIO

74HL044B

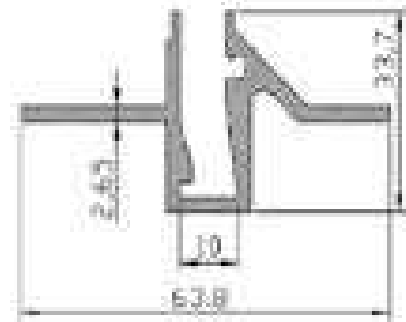

End Cap



Air Profile (End Cap)



Air Profile (Block)

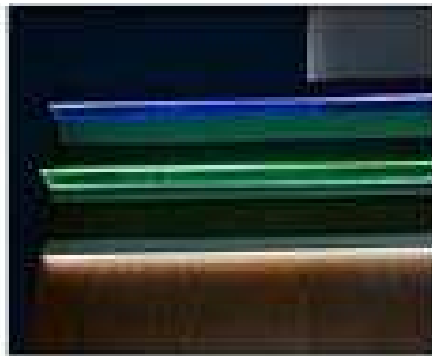
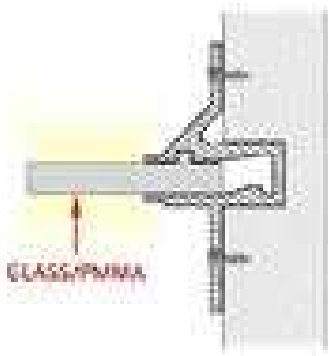

PROFILI PER MOBILIO

74BAPMENSOLA



PROFILI PER MOBILIO

74HL069



End Cap



Alu Profile (Back)



Screws

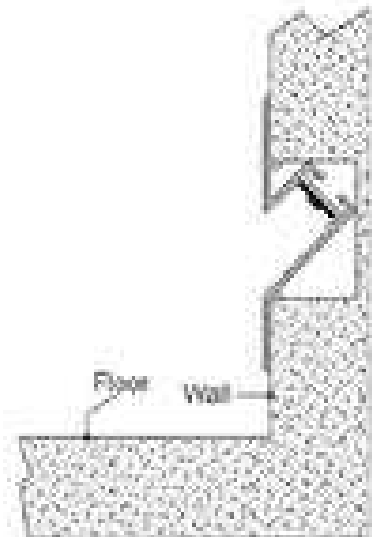

PROFILI PER MOBILIO

74AP14



Material	Al 6063-T5
Surface	Anodized aluminium
PC Color	Frost/Transparent/Milk
Range width	Within 12mm
Available length	0.5m-2.5m
Installation	Surface mounted with screw or clip

Applications

Lighting, Indoor LED lighting, Furniture LED Lighting, Store shelf LED Lighting, Window display LED Lighting, Exhibition booth LED Lighting, Cove LED Lighting, Bias LED Lighting

74AP14F

74AP14T

74AP14M



Frost, AP14F



Transparent, AP14T



Milk, AP14M

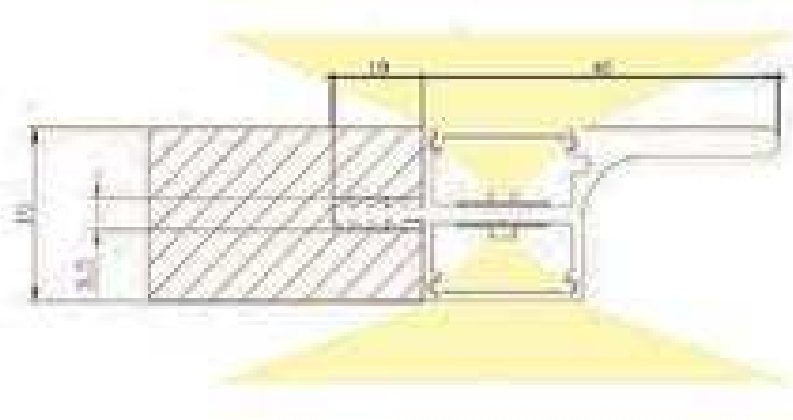
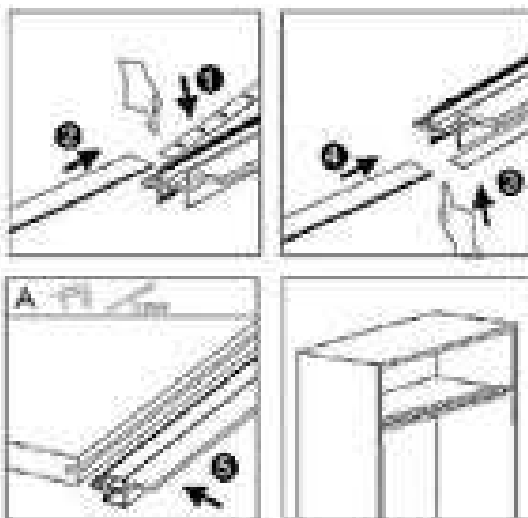

PROFILI PER MOBILIO

74SKYLINE

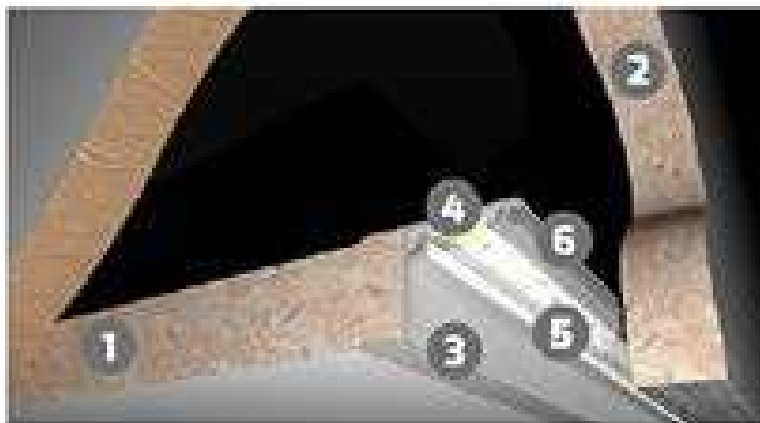
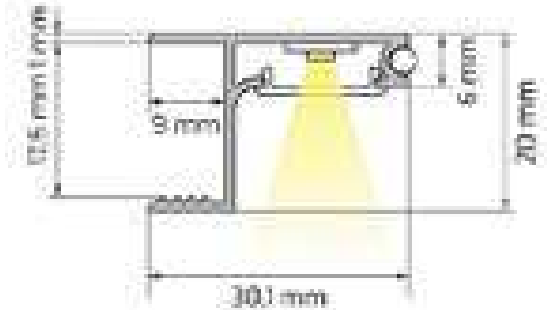

1. Pannello inferiore del pensile
2. Pannello anteriore del pensile
3. Profilo Skyline
4. LED strip
5. Lente diffusore del profilo
6. Distanziatore (prodilo in gomma)

PROFILI PER MOBILIO

74SKYLINE

Codice	Lente	Lunghezza
74SKYLINE-N-OP-2M	Opaca	2 mt.
74SKYLINE-N-OP-3M	Opaca	3 mt.
74SKYLINE-N-TR-2M	Trasparente	2 mt.
74SKYLINE-N-TR-3M	Trasparente	3 mt.

ACCESSORI:

Distanziatore in gomma trasparente Cod. 740P2-DY-SKYLINE-TR-01



PROFILI PER MOBILIO

74FLOOR-TR-2M

74FLOOR-TR-3M

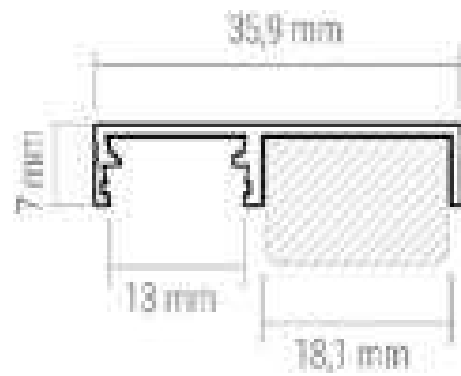

1. Pannello inferiore del mobile
2. Pannello frontale del mobile
3. Profilo Floor Line
4. Zoccolo del mobile



PROFILI PER MOBILIO

74SKYLINE -W

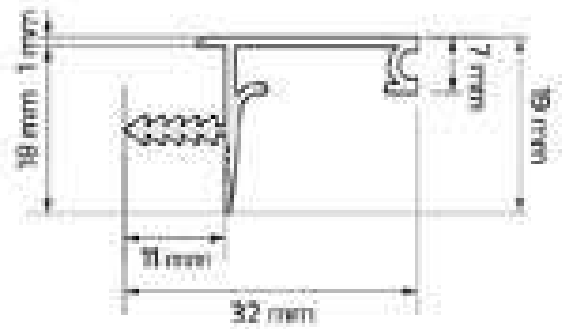

1. Pannello inferiore del mobile
2. Pannello anteriore del mobile
3. Profilo
4. Led Strip
5. Lente diffusore del profilo
6. Distanziatore (profilo in gomma)

PROFILI PER MOBILIO

74SKYLINE -W

Codice	Lente	Lunghezza
74SKYLINE-OP-2M-W	Opaca	2 mt.
74SKYLINE-OP-3M-W	Opaca	3 mt.
74SKYLINE-TR-2M-W	Trasparente	2 mt.
74SKYLINE-TR-3M-W	Trasparente	3 mt.

ACCESSORI:

Distanziatore in gomma trasparente Cod. 74OP2-DY-SKYLINE-TR-01

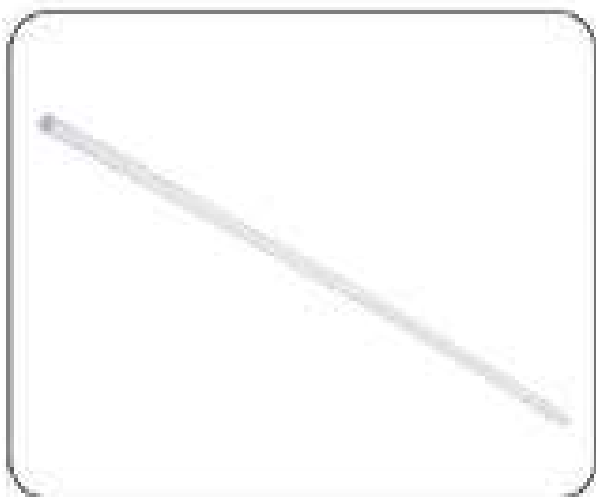

74ALP076

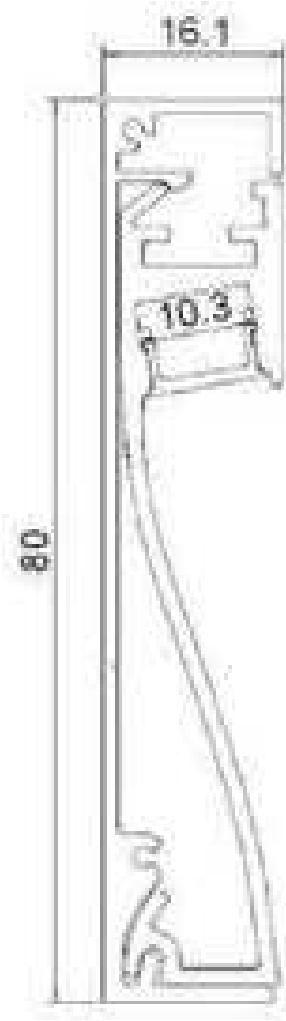

PROFILI PER PAVIMENTI

74BAPL009





End cap with hole
End cap without hole

74BAPL009EC1
74BAPL009EC0



Aluminum profile

74BAPL009PR

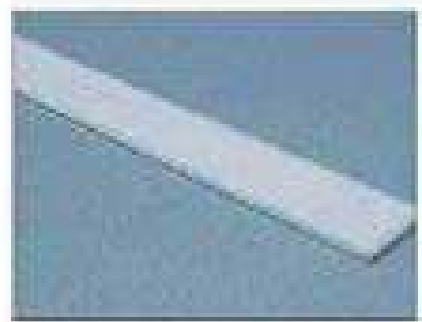

PMMA opal matte cover

74BAPL009O

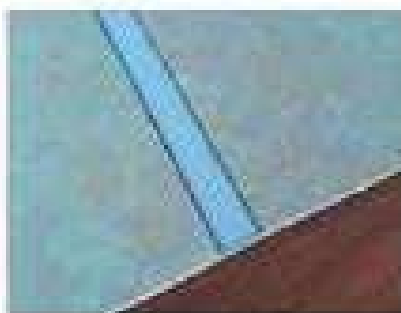
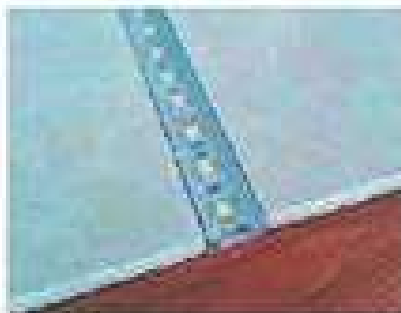

PROFILI PER PAVIMENTI

74BAPLO34

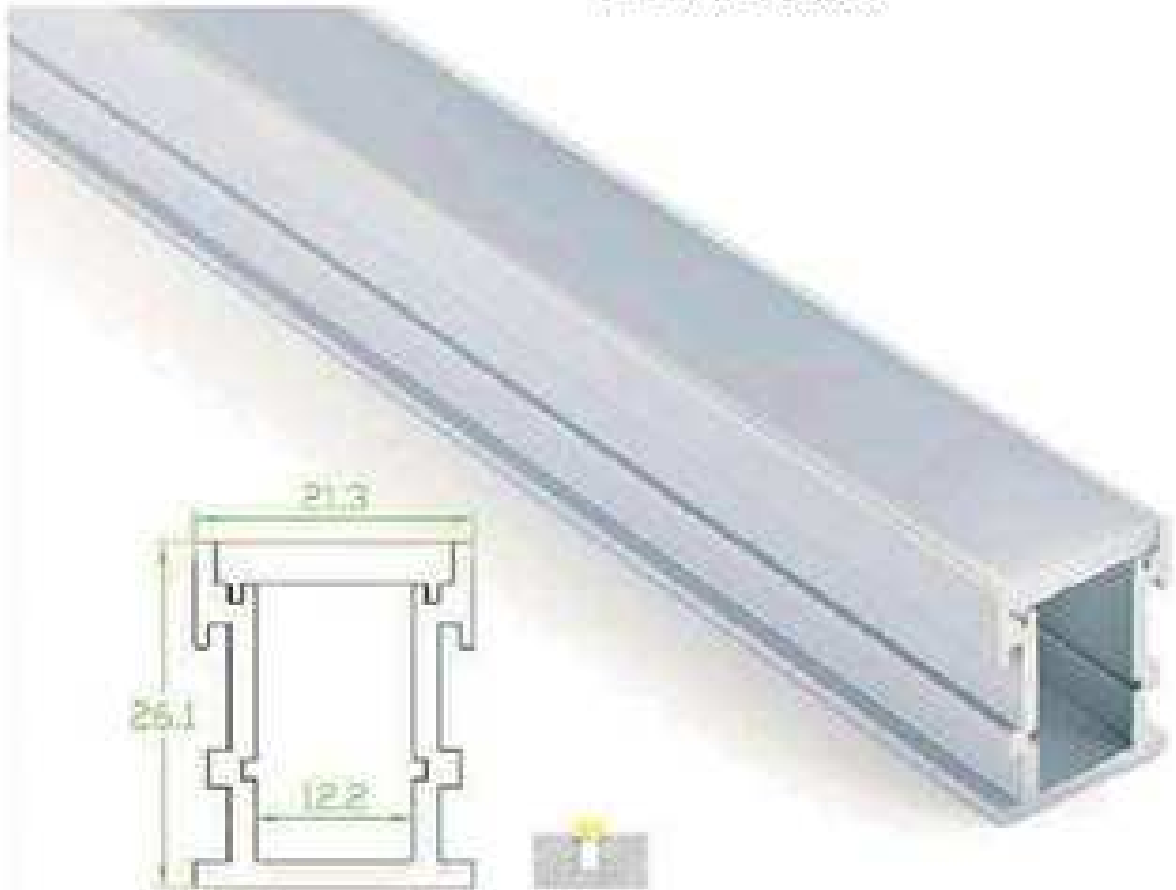



End cap with hole
End cap without hole

74BAPLO34EC1
74BAPLO34EC0



Aluminum profile

74BAPLO34PR



PC diffused cover

74BAPLO34D

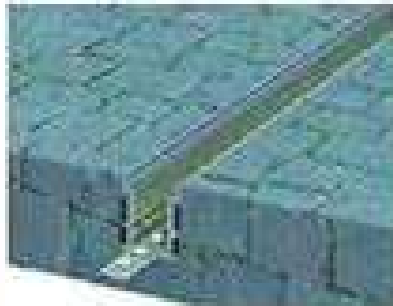

PROFILI PER PARETI

74WAY10

SPECIAL APPLICATION PROFILE

max 30 mm

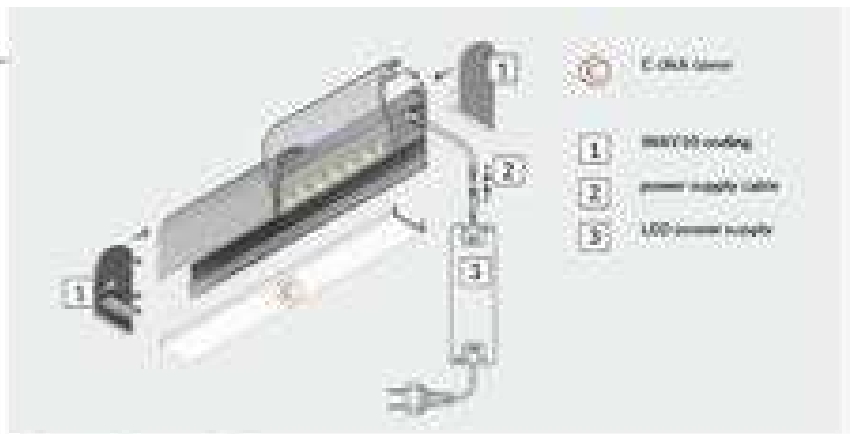
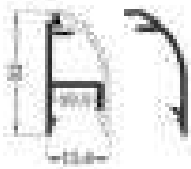

- LED strip
- 1** 74WAY10 coating
- 2** power supply cable
- 3** LED control supply

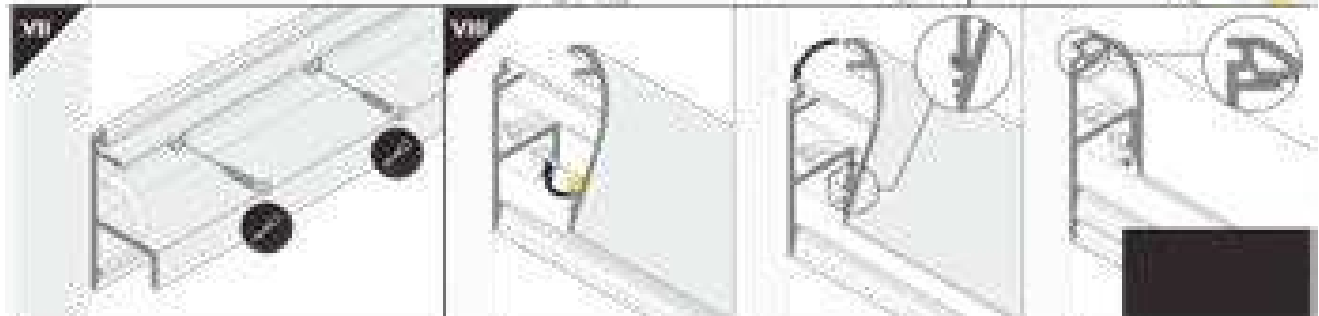
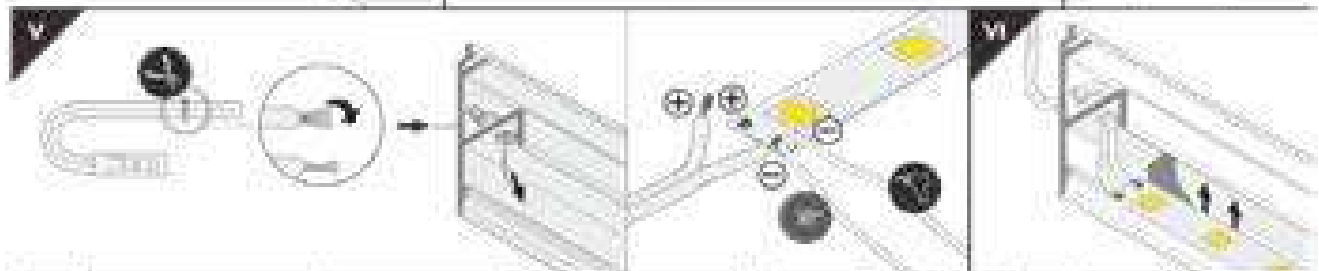
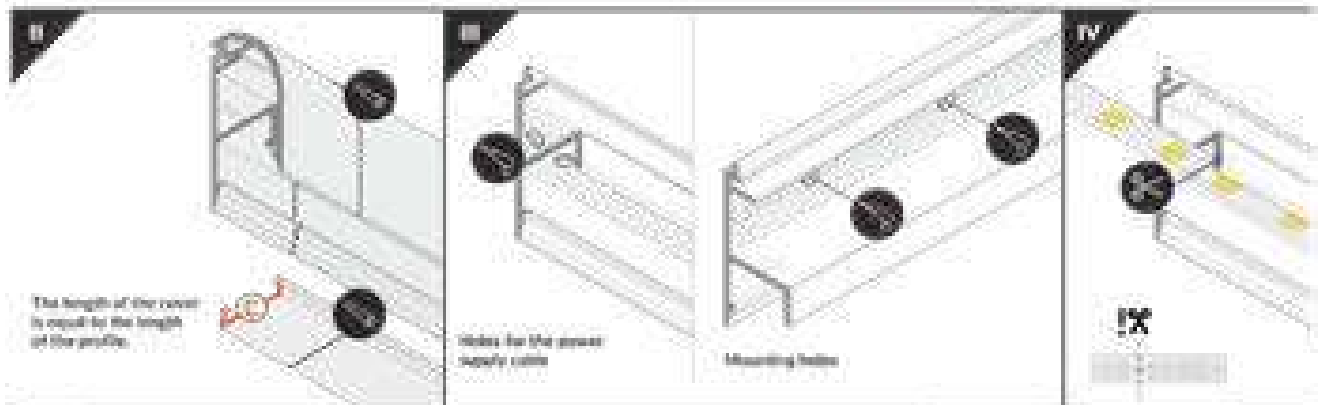
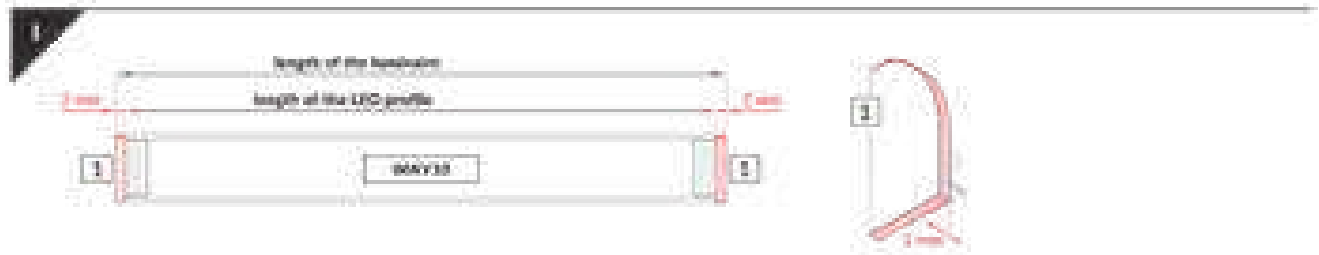

PROFILI PER PARETI

74BAPL011

74BAPL011TEST

74BAPL011EC1

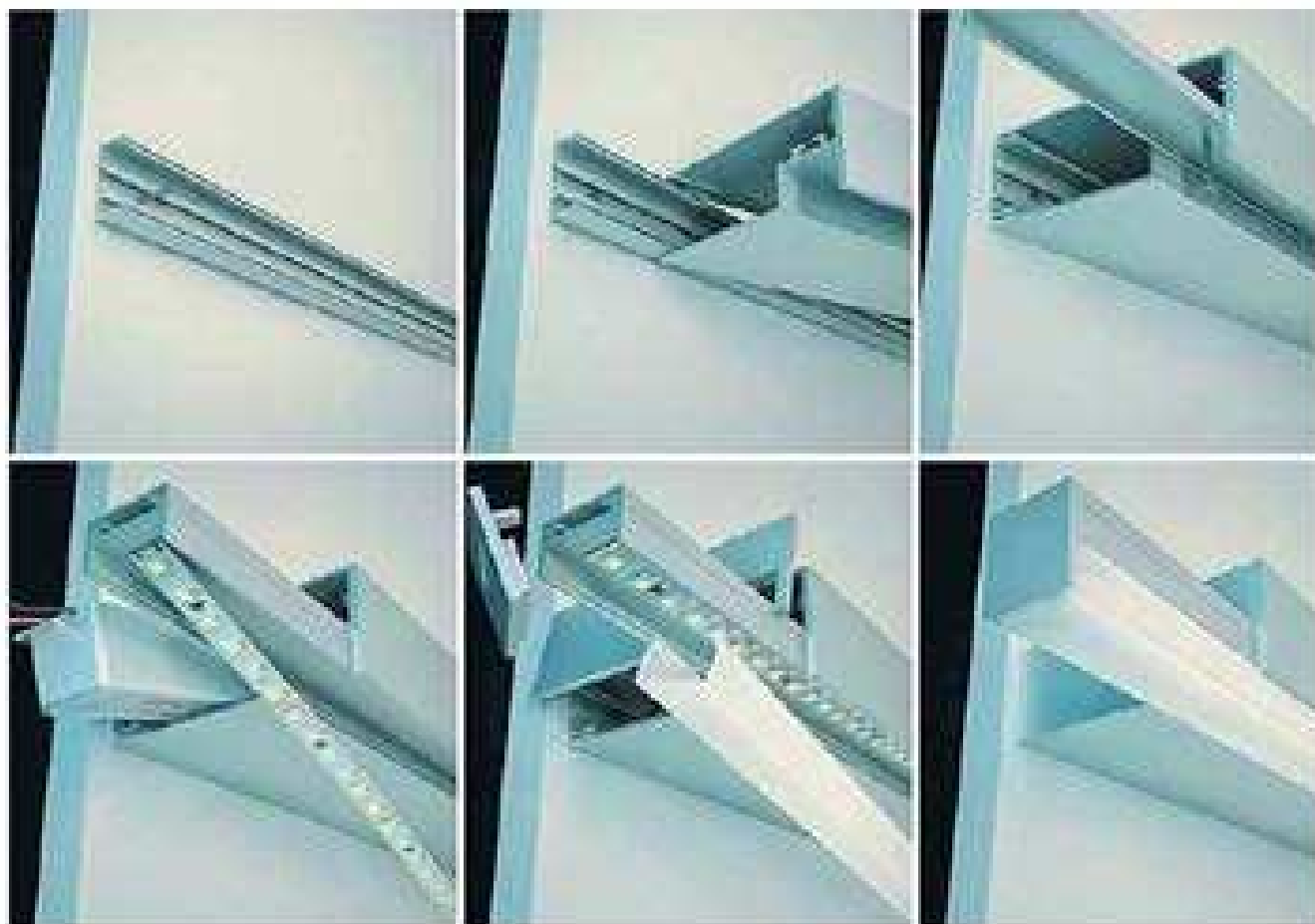



PROFILI PER PARETI

74BAPL019

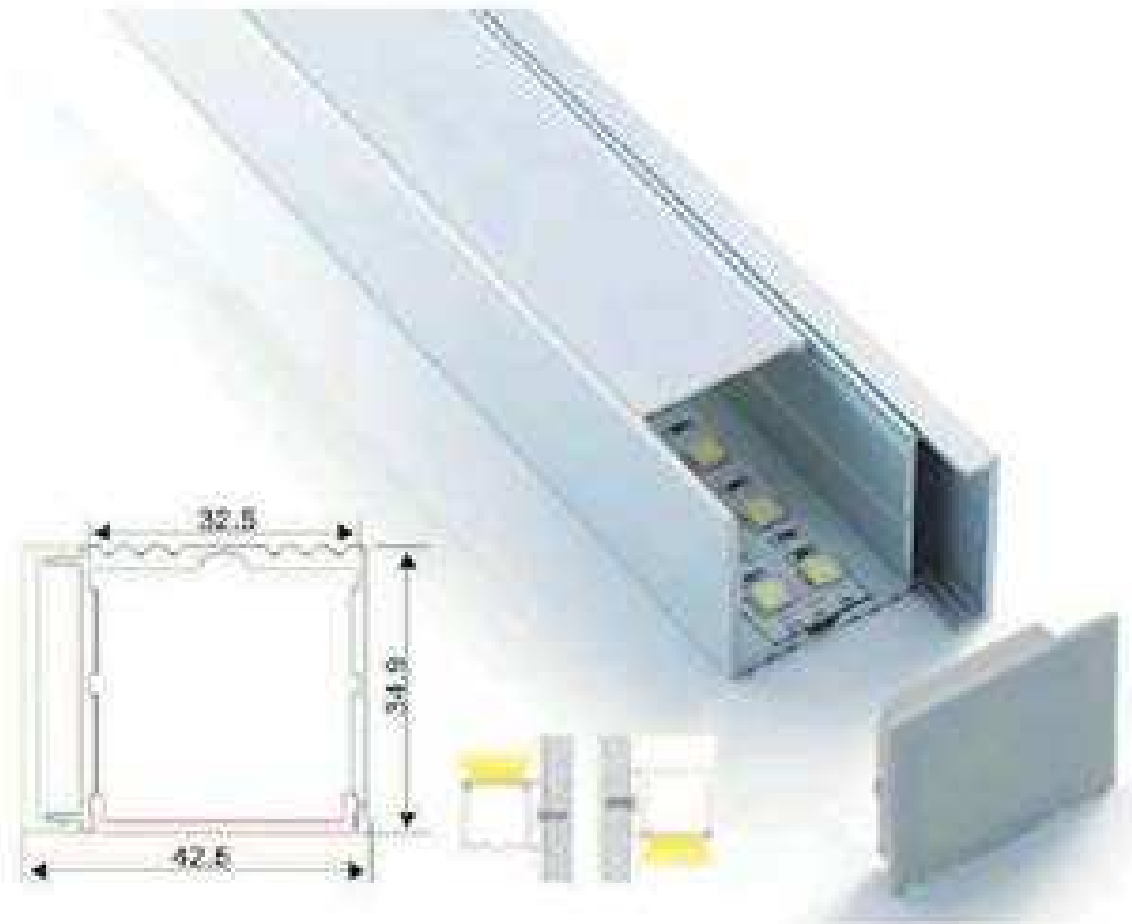



End cap with hole
End cap without hole

74BAPLO19EC1
74BAPLO19ECO



Aluminum profile

74BAPLO19PR



Mounting profile

74BAPLO19MP



Aluminum profile for strips

74BAPLO19PRS



PMMA opal matte cover
PMMA semi-clear cover
PC diffused cover

74BAPLO17O
74BAPLO17ST
74BAPLO17D

PROFILI PER PARETI

74POLY/A
74POLY/B

74POLY/A



• Dimensioni: 200 x 14,7 x 14,7

74POLY/B



• Dimensioni: 200 x 8,5 x 8,5

PROFILI PER PARETI

74BAP70170

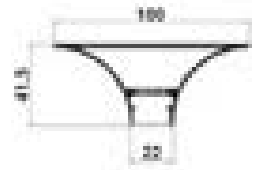

PROFILI PER PARETI

74BAPL023

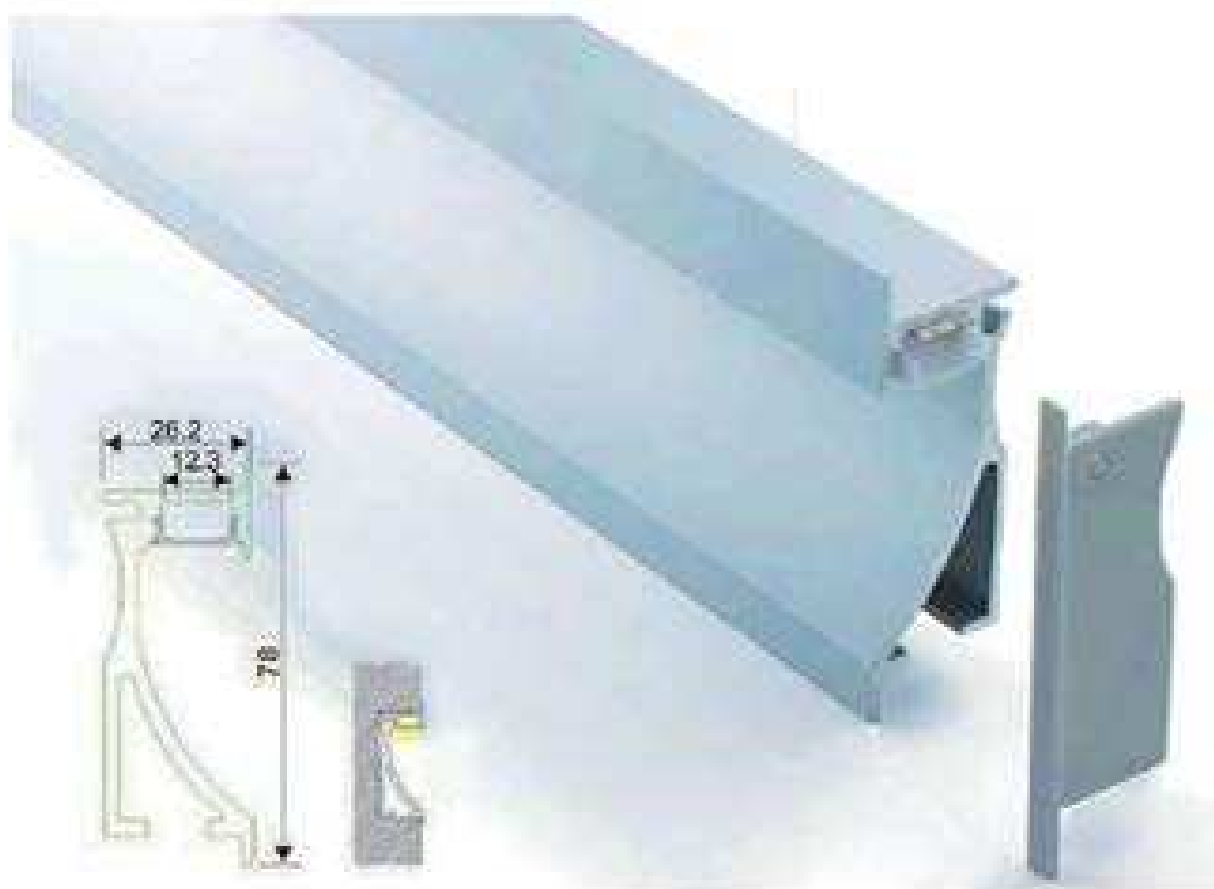



End cap with hole
End cap without hole

74BAPL023EC1
74BAPL023EC0



Aluminum profile

74BAPL023PR



PMMA opal matba cover
PMMA semi-clear cover
PMMA clear cover
PC diffused cover

74BAPL0010
74BAPL0015T
74BAPL001T
74BAPL0010

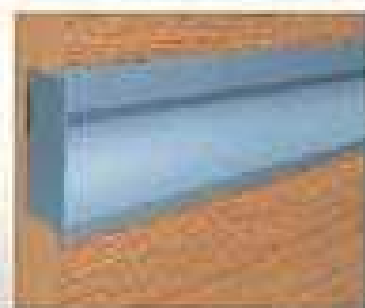
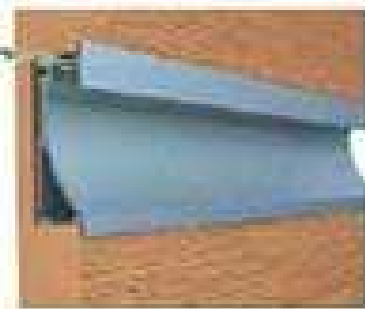

PROFILI PER PARETI

74BAPL050

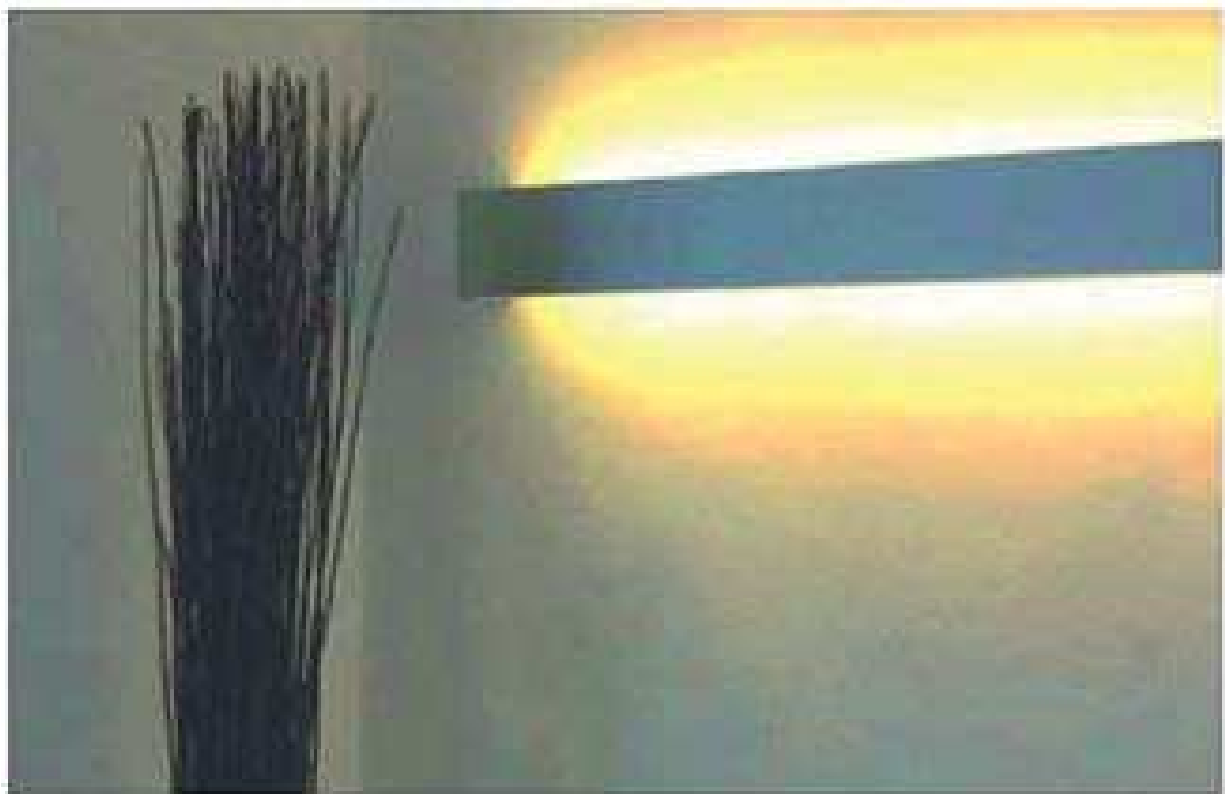
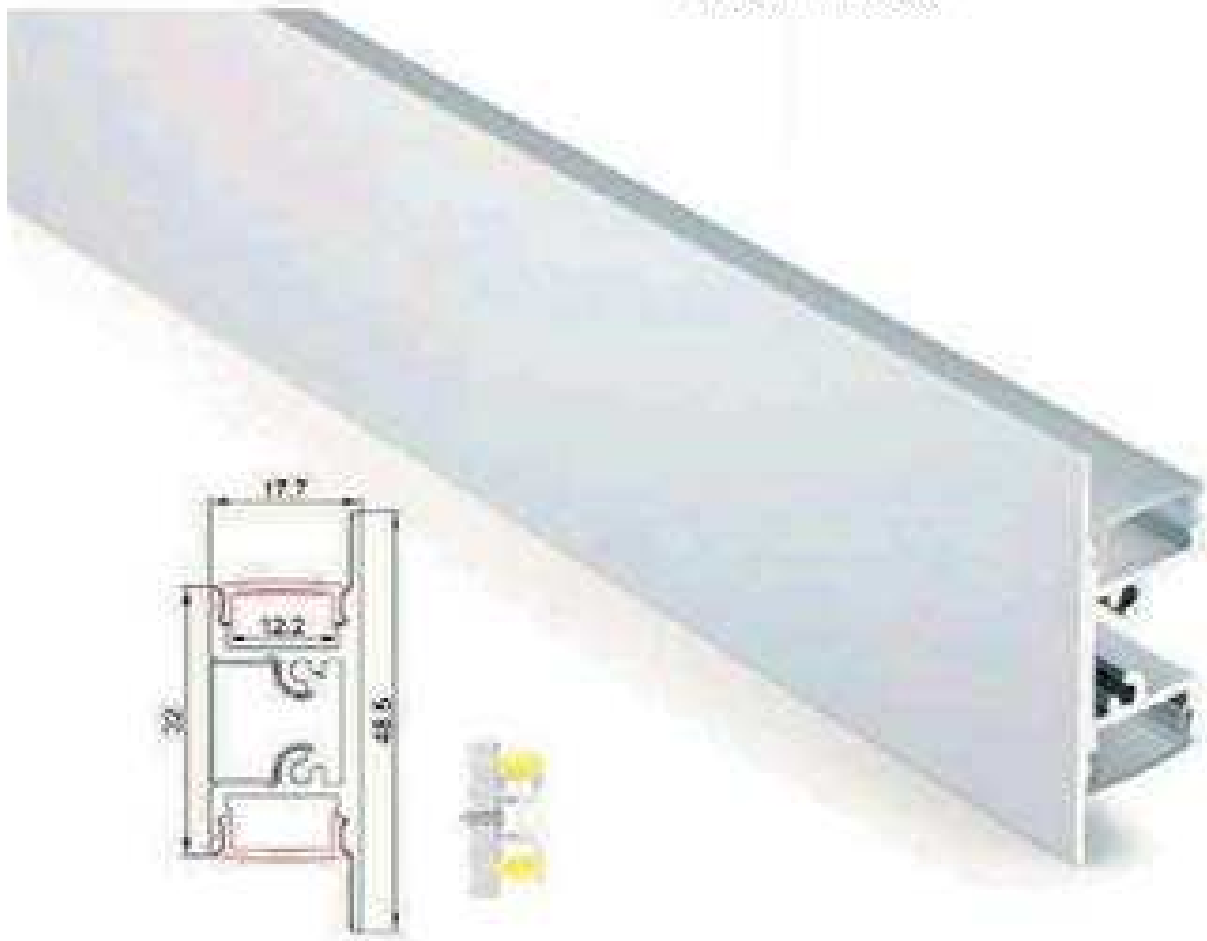

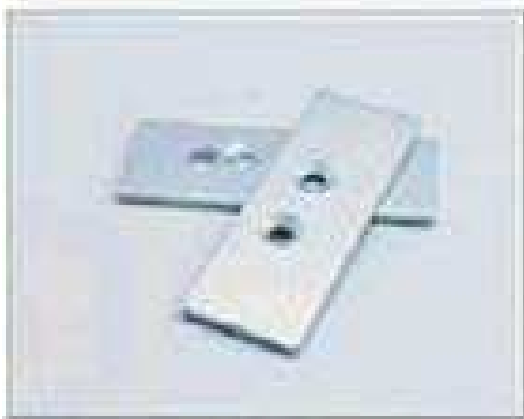

End-cap with hole
End-cap without hole

74BAPL050EC1
74BAPL050ECO



Aluminum profile

74BAPL050PR



PMMA opal matte cover
PMMA semi-clear cover
PMMA clear cover
PC diffused cover

74BAPL0010
74BAPL001ST
74BAPL001T



Mounting clip(metal)

74BAPL050MCM

PROFILI PER PARETI

74ALP38115

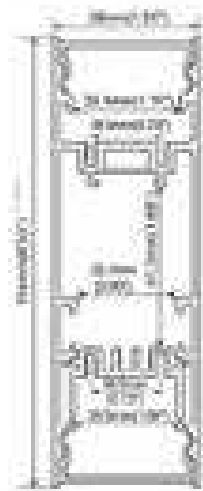
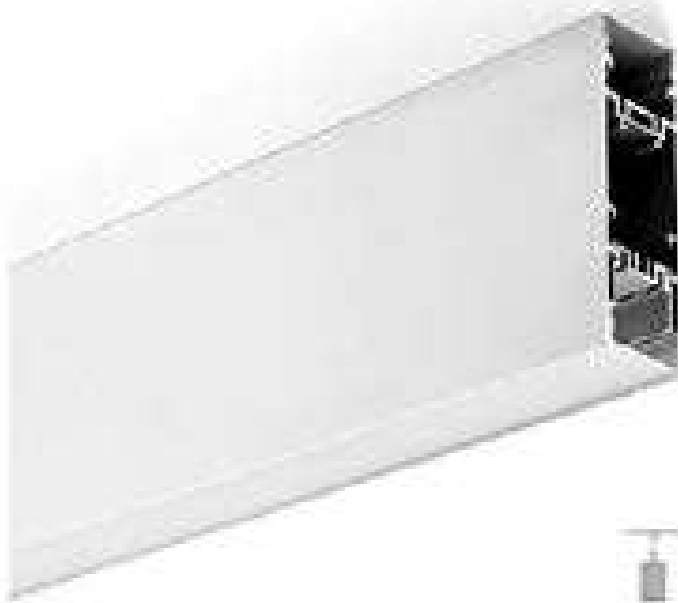

Slanted end cap



Wall clip



Inside clip



Hanging bracket



Dust cap



Safety wire



PROFILI PER PARETI

74BAPL049

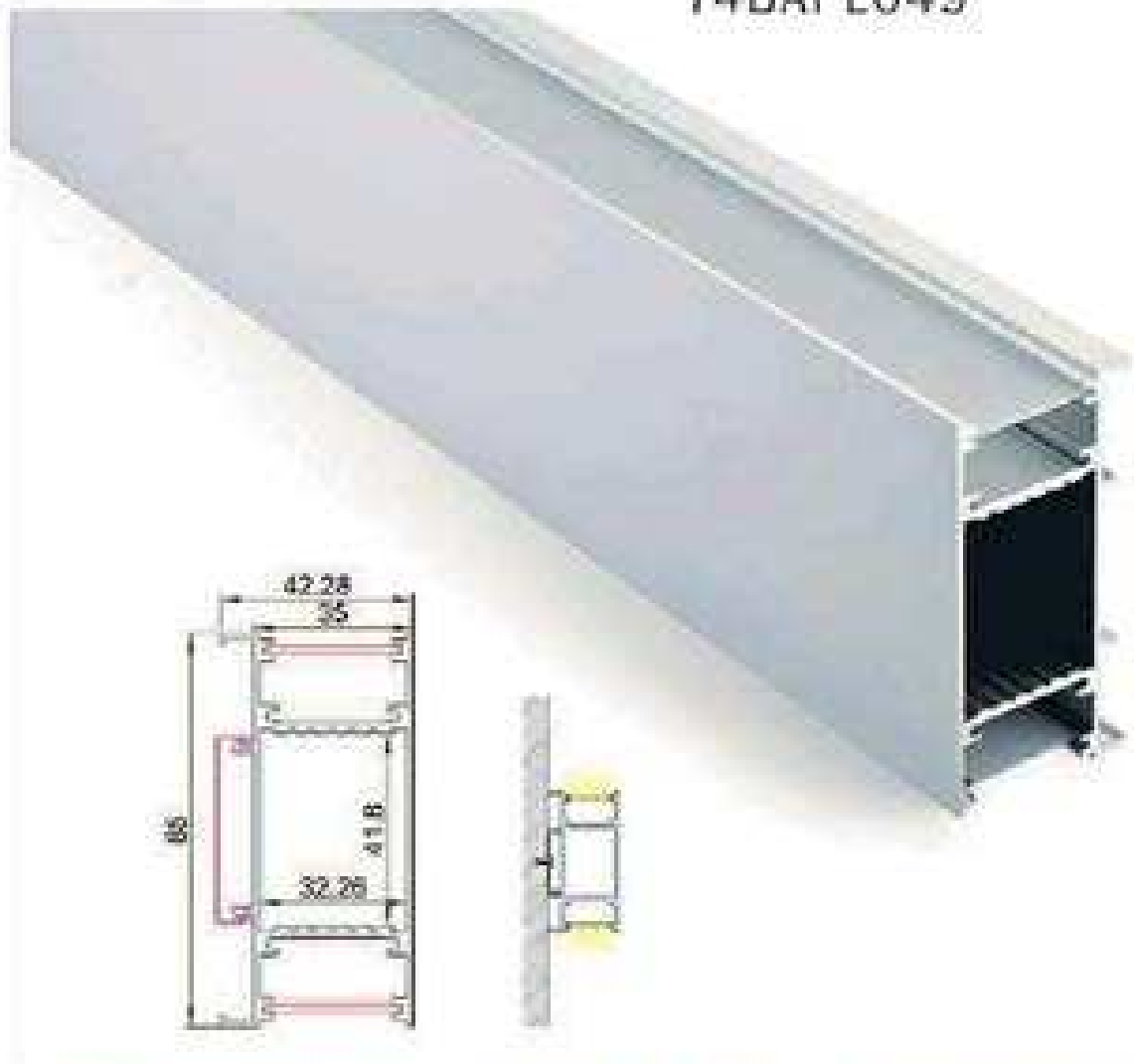



Aluminum profile

74BAPL049PR



PC semi-clear cover
PC diffused cover

74BAPL049ST
74BAPL049D



End cap without hole

74BAPL049ECO



Mounting clip(metal)

74BAPL049MCM

PROFILI PER PARETI

74BAPL062





Aluminum profile

74BAPL062PR



Mounting Profile

74BAPL062MP



End cap without hole

74BAPL062ECO



PMMA opal matte cover
PMMA semi clear cover
PC diffused cover

74BAPL0010

74BAPL001ST

74BAPL001D

PROFILI PER PARETI

74BAPLO63





PROFILI PER PARETI

74WALLE12

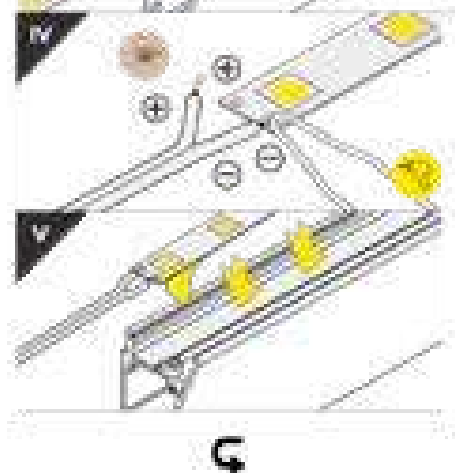
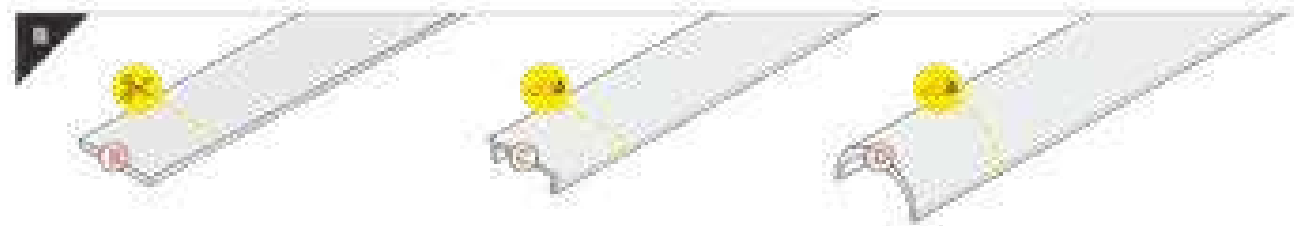
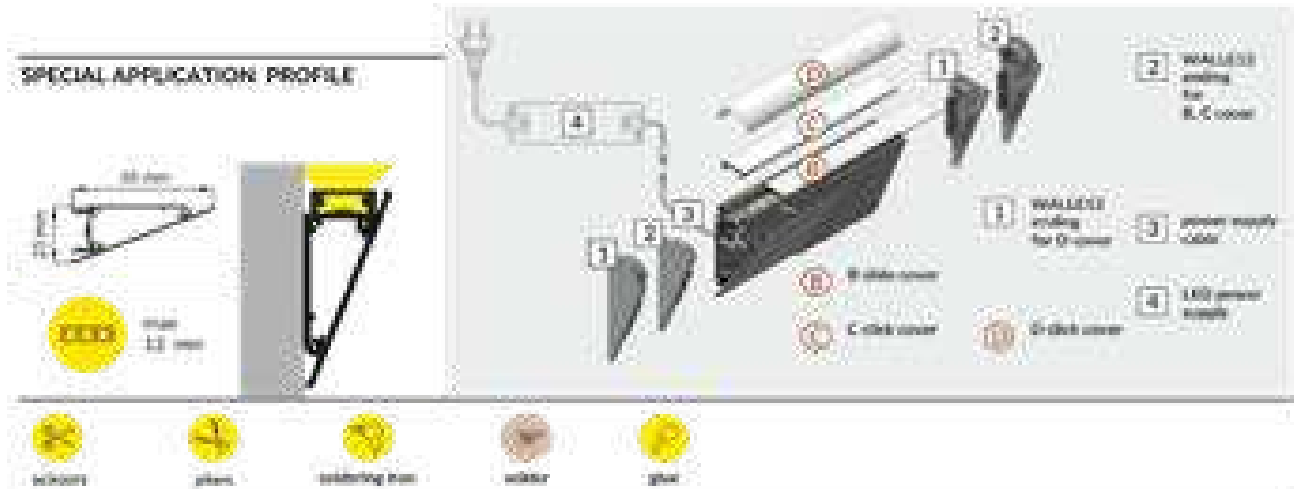



SOLO SU RICHIESTA

PROFILI PER PARETI

Types of installation:



Material: Extruded aluminum

Dimension: 76.2x76.2mm

Length: MAX 3m



74ALP190

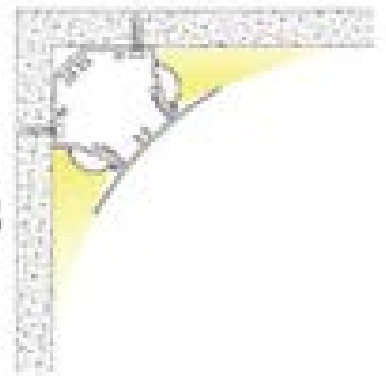

FINISH



Anod aluminum

White

Black

END CAPS



End Caps

DIFFUSERS

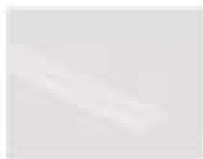

PC diffused





SOLO SU RICHIESTA

PROFILI PER PARETI

Types of installation:



Material: Extruded aluminum
Dimension: 42x35mm
Length: MAX 3m



74ALP019-R

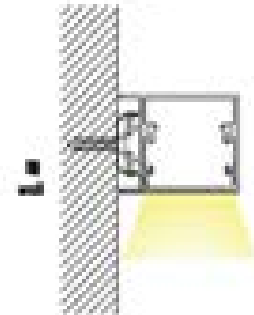
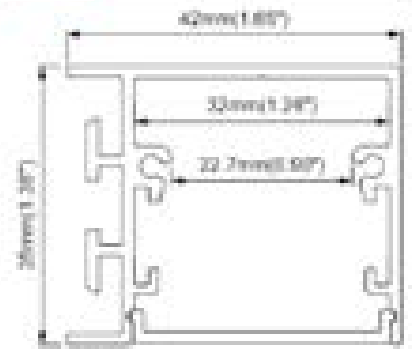

END CAPS

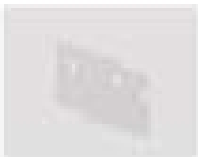

End cap with hole
End cap without hole

FINISH



Anod. aluminum



White



Black

DIFFUSERS



PC diffused

ACCESSORIES



90° Horizontal connector



90° Vertical connector



180° Connector



Mounting clip (metal)



SOLO SU RICHIESTA

PROFILI PER PARETI



Types of installation:



Material: Extruded aluminum
Dimension: 114,2x50,1mm
Length: MAX 3m

74ALP193

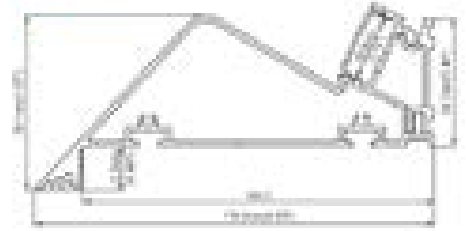

FINISH



Anod. aluminum



White



Black

END CAPS



End Caps

DIFFUSERS



PC diffused

ACCESSORIES



90° Connector



90° Vertical connector



180° Connector





SOLO SU RICHIESTA

PROFILI PER PARETI

Types of installation:



Material: Extruded aluminum

Dimension: 38.7x39mm

Length: MAX 3m



74ALP191

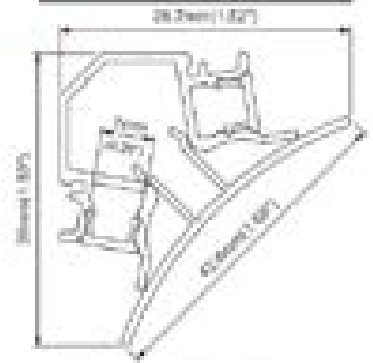

END CAPS



End Caps

DIFFUSERS

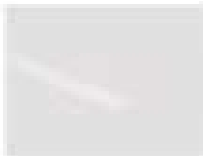

PC diffused

ACCESSORIES

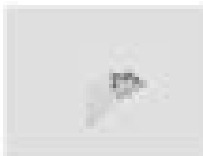

Mounting clip (metal)

FINISH



Anod. aluminum



white



Black





SOLO SU RICHIESTA

PROFILI PER PARETI

74ALP192

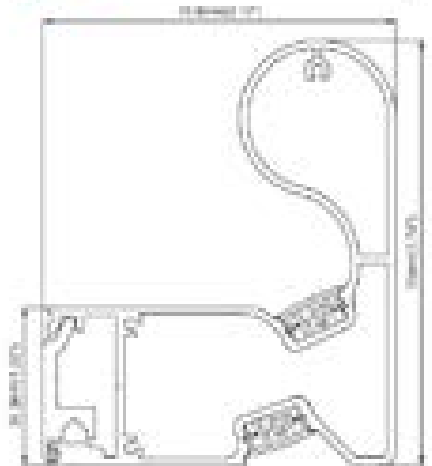

Types of installation:



P20

Material: Extruded aluminum
Dimension: 78.8x95mm
Length: MAX 3m

FINISH



Anod. aluminum



White



Black

END CAPS



End Caps

DIFFUSERS

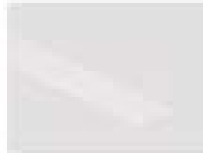

PC diffused

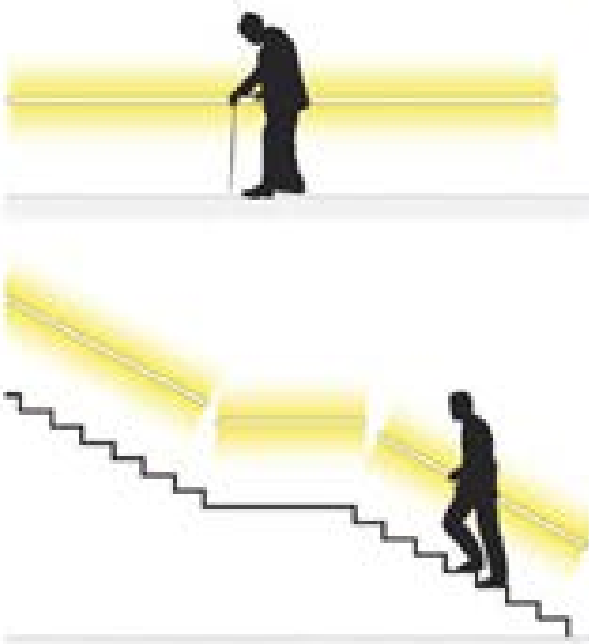
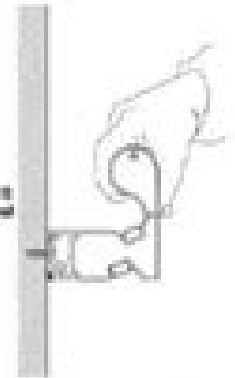



SOLO SU RICHIESTA

PROFILI PER SOFFITTO

74ALP141



Types of installation:



Material: Extruded aluminum
Dimension: 24x21.2mm
Length: MAX 3m

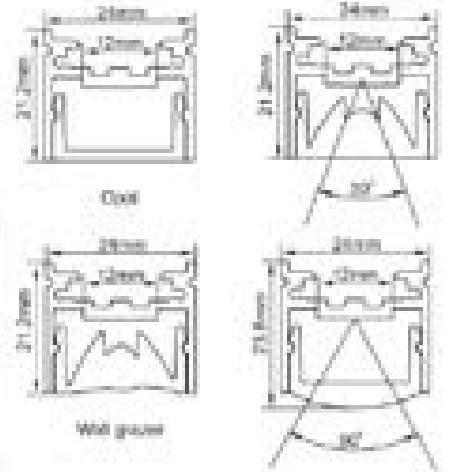

END CAPS



End Caps

FINISH



Anod aluminum white black

DIFFUSERS



PC diffused



PMMA lens

ACCESSORIES



Mounting clip (metal)



Adjustable bracket

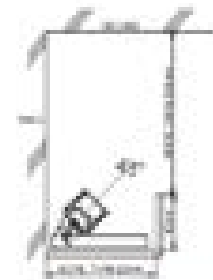
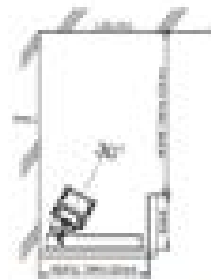
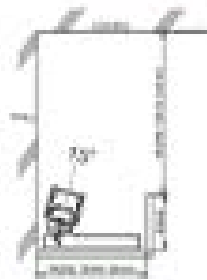
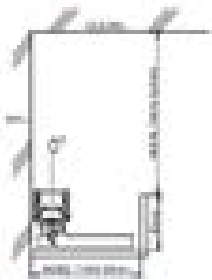

0° Adjustable



15° Adjustable



30° Adjustable



45° Adjustable

PROFILI PER SOFFITTO

74ALP9035



PC limited cover

Aluminium End Cap
without hole



Connector I

Stainless Clip



Connector L

Connector IL



Connector X

PROFILI PER SOFFITTO

74ALP9575-R

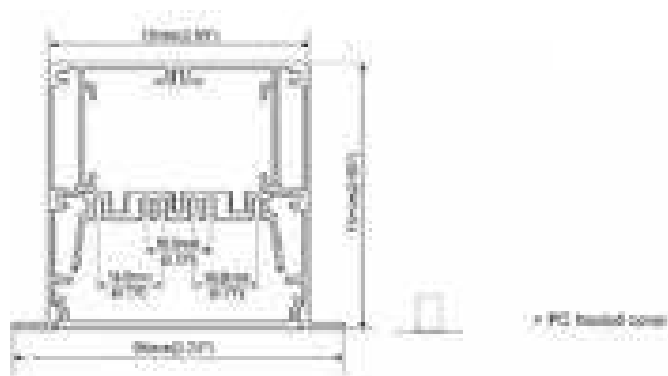

Aluminium end cap
without hole



Connector T

Stainless clip



Connector L

Internal clip



Connector X

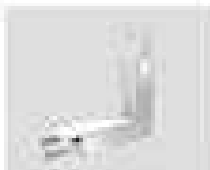

Connector IL

PROFILI PER SOFFITTO

74ALP9575-RD

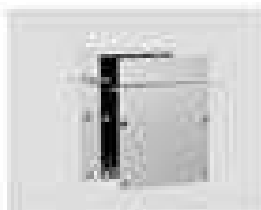
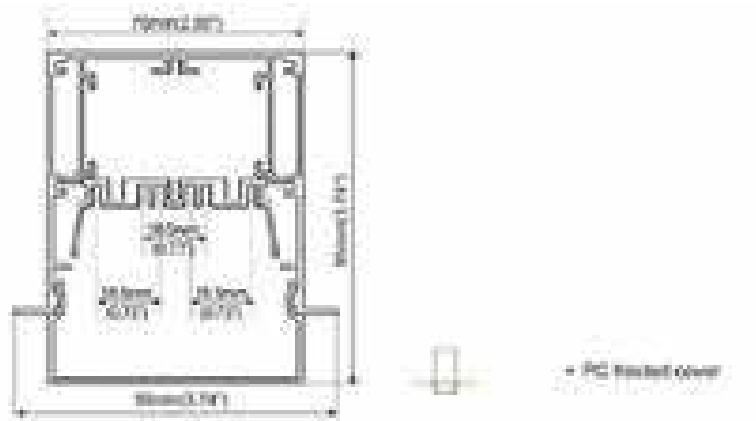

Aluminium end cap



Stainless cap

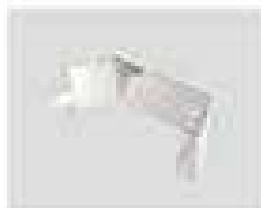

Internal clip

PROFILI PER SOFFITTO

74ALP12335



Aluminium End Cap
without hole



Connector T

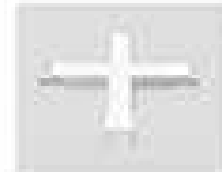

Connector X



Stainless Clip



Connector L



Connector II



PROFILI PER SOFFITTO

74ALP12575

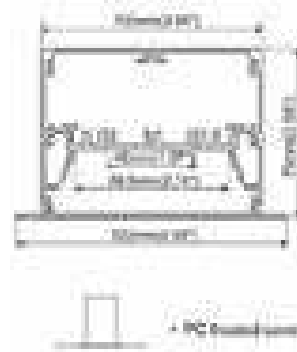

Aluminum end cap without hole



Connector T

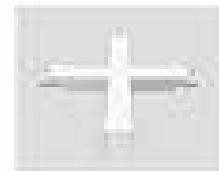

Connector X



Stainless clip



Connector L

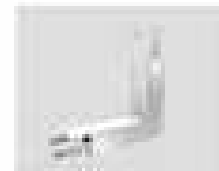

Connector IL



Internal clip



PROFILI PER SOFFITTO

74BAPL017



PROFILI PER SOFFITTO

74ALP045R

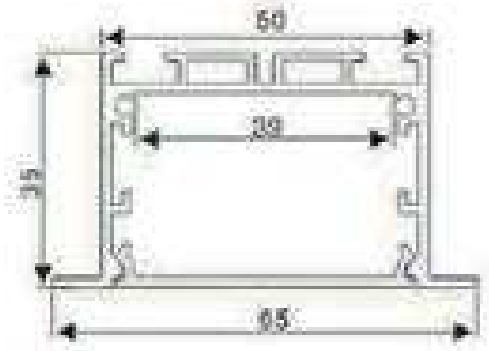
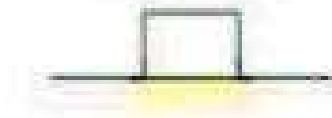

PC diffused cover

74ALP045RDC



Aluminium End Cap
without hole

74ALP045RECO



Aluminium profile

74ALP045RPR



Stainless Clip

74ALP045RSC

PROFILI PER SOFFITTO

74ALP045RD

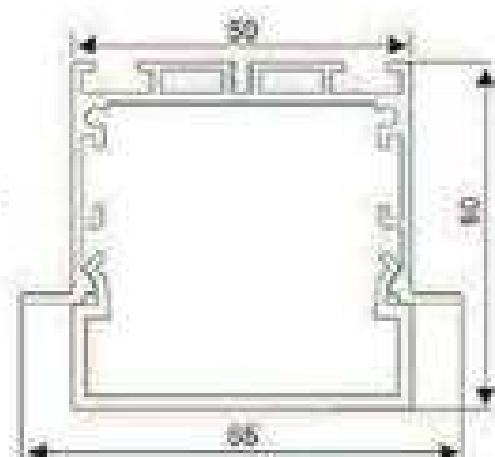
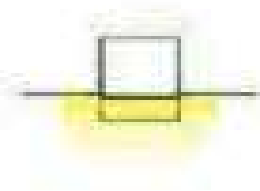

PC Frosted cover
74ALP045RDGH



Aluminium end cap
74ALP045RDEC



Aluminium profile
74ALP045RPR



Stainless Clip
74ALP045RSC



Connector T
74ALP045RDCT



Connector L
74ALP045RDCL

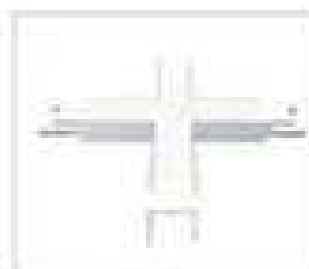

Connector X
74ALP045RDCX



Connector IL
74ALP045RDCIL



PROFILI PER SOFFITTO

74ALP7575-R

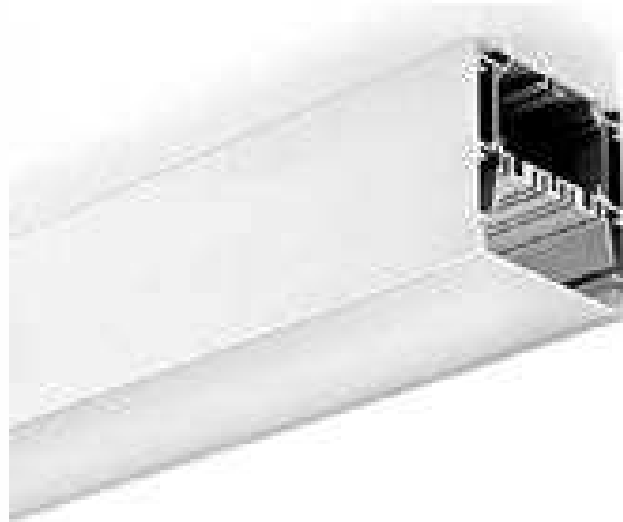

• PC frosted cover

Aluminium End cap
without hole



Steel wire

Stainless clip



Connector T

Internal clip



Connector L

Trimless
recessed clip

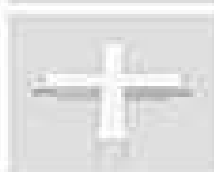

Connector X

PROFILI PER SOFFITTO

74ALP7575-RD

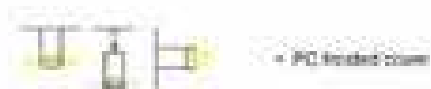
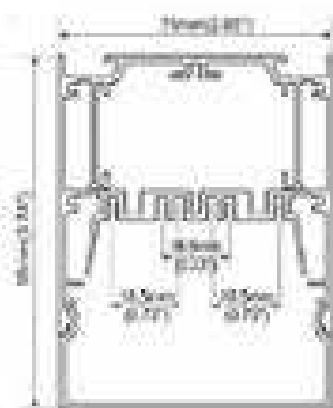

Aluminum End Cap



Internal Clip



Stainless Clip

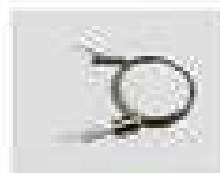

Steel wire

PROFILI PER SOFFITTO

74ALP7575-RL

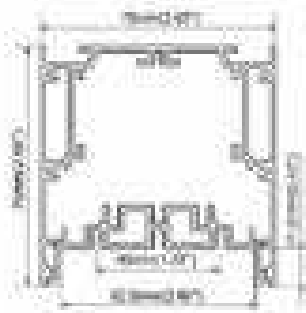
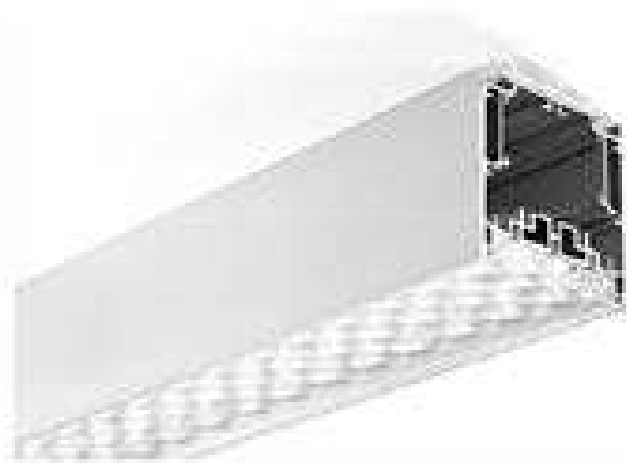

Lens: 30/60 degrees,
asymmetrical or
symmetrical



Internal clips



Steel wire

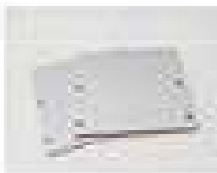

End cap



Outside clips

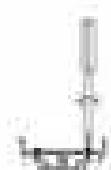

Step 01



Step 02



Step 03



Step 04



Step 05

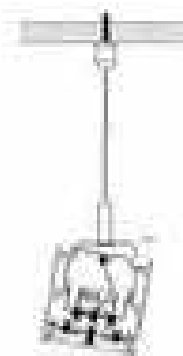

Step 06

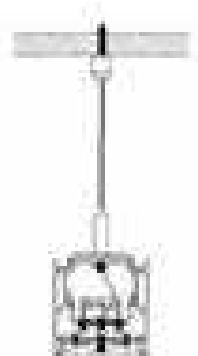

Step 07

PROFILI PER SOFFITTO

74ALP7595-UP

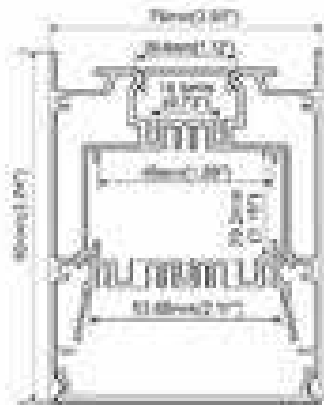
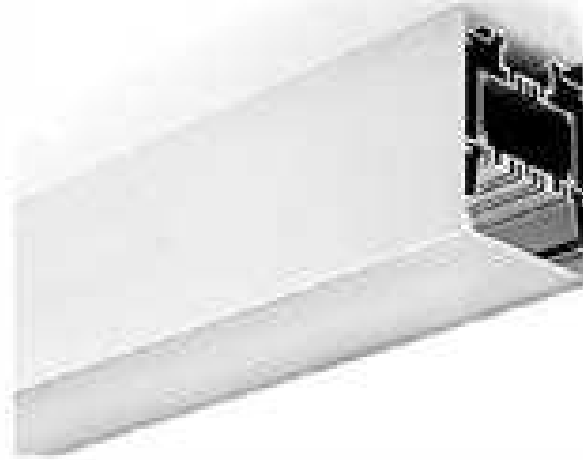

- PC frosted cover

Aluminium profile

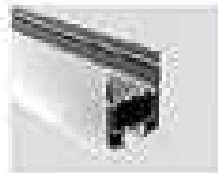

Internal clip

PC frosted cover



Stainless clip

PC frosted cover



5000 wire

Aluminium end cap



PROFILI PER SOFFITTO

74ALP25C-R

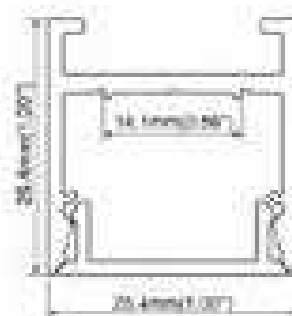
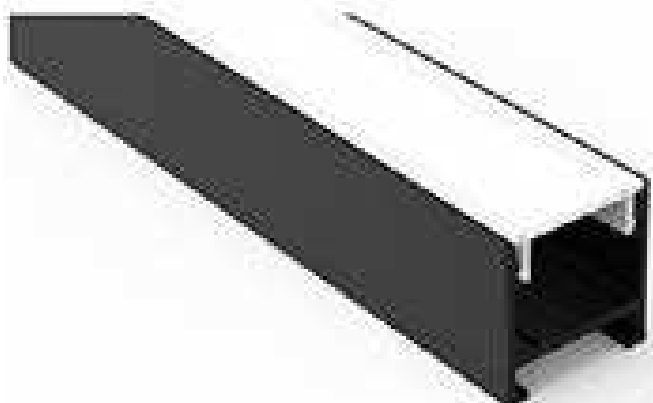

+ FISSA sul metallo con...

PROFILI PER SOFFITTO

74ALP25C-R



Connector



Steel wire



Curve led board 600 mm



PROFILI PER SOFFITTO

Installation Methods



Step 01
Connecting the curved profile by connector



Step 02
Stick the last board inside the profile



Step 03
Press the curved cover into the profile

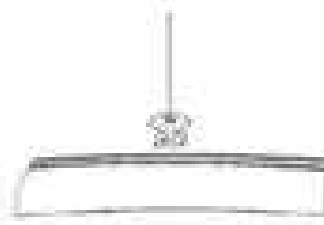

Step 04
Move the wire to another position



Step 05
Lock the wood



Step 06
Hang the circle by the steel wire

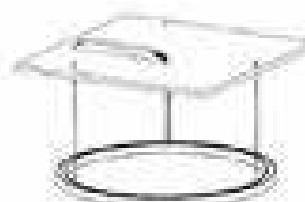

Step 07
Connecting the driver

PROFILI PER SOFFITTO

74ALP50C

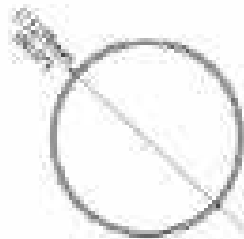
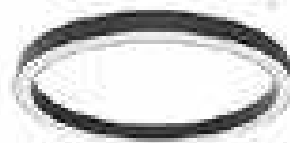
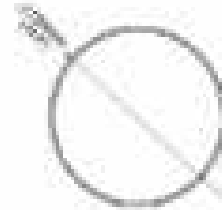
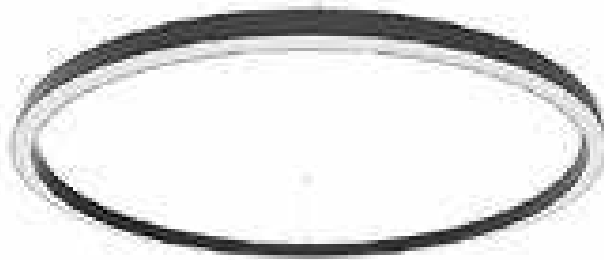

• LED strip light cover



Hanging clip



Curved led board



Connector



Steel wire

PROFILI PER SOFFITTO

Free combination



74LS30-4A



74LS30-4B



74LS30-2A

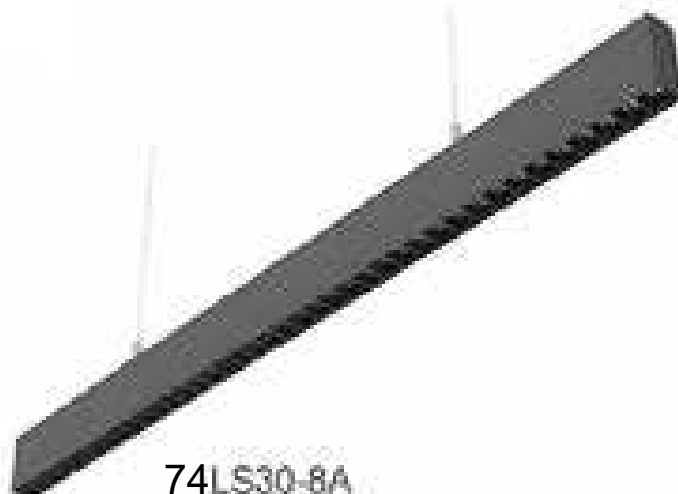

74LS30-8A

PROFILI PER SOFFITTO

Installation Methods

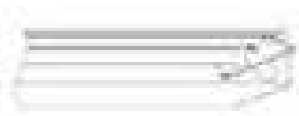

Step 01:
Install the end caps

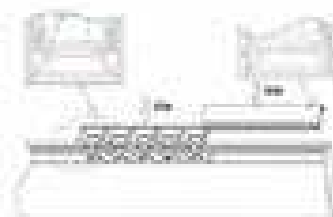

Step 02:
Push the integrable cover
and blind cover inside



Step 03:
Fix the led module



Step 04:
Fix the reflector



Step 05:
Fix the external lip



Step 06:
Fix the internal clips
and the driver



Step 07:
Fix the steel wire



Step 08:
Fix the gear box
and the safety wire



Step 09:
Installation completed

PROFILI PER SOFFITTO

Free combination



74LS50-2A

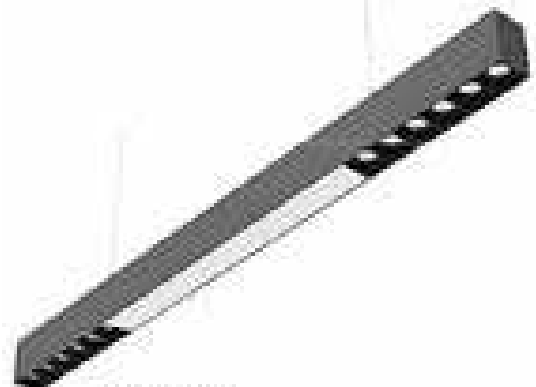

74LS50-2B



74LS50-4A



LS50-Wall Washer



74LS50-Reflective Louver

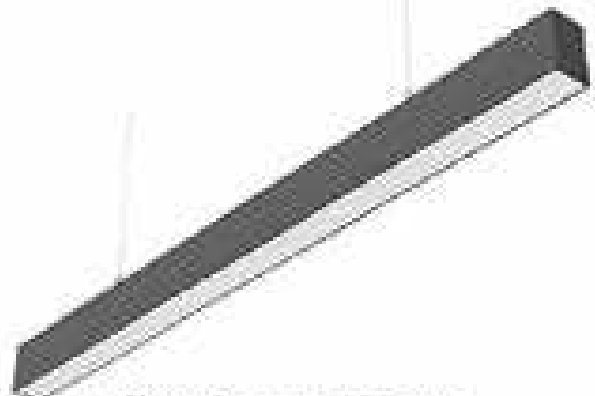

74LS50-Prismatic Cover

PROFILI PER SOFFITTO

Installation Methods

Installation with reflector



Installation with reflective louver



Installation with wall washer



PROFILI PER SOFFITTO

74LS50

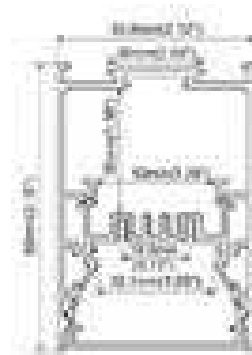

GNC end caps without hole



Prismatic cover



Reflector 15°, 30°, 45°



Inside clip



PC frosted cover



Wall washer



Outside clip



Blind cover



High reflective louver

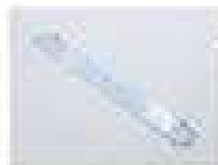

Led module



Steel wire



Safety wire



90° Connector



180° Connector



Internal clip



Prismatic 3 in 1



Prismatic+lens

PROFILI PER SOFFITTO

74LS30

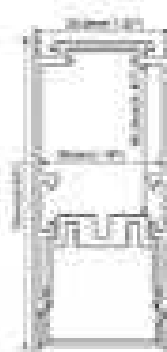

End cap



Blind cover



Reflector: 15°, 30°, 45°



Inside clip



LED module



90° connector



Outside clip



Steel wire



180° connector



PC frosted cover



Safety wire

PROFILI PER SOFFITTO

74LS30-T

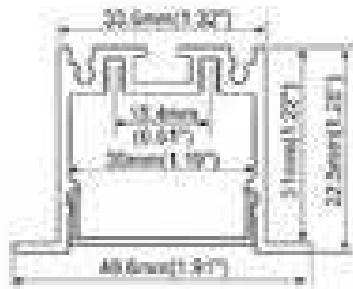

End caps



Blind cover



PC frosted cover

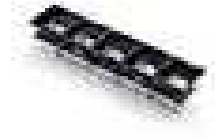

Reflector MR3049



Spring clip

PROFILI PER SOFFITTO

74LINEA20

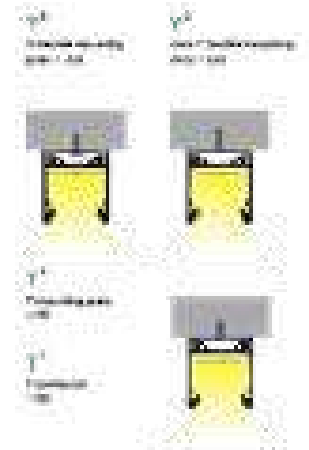
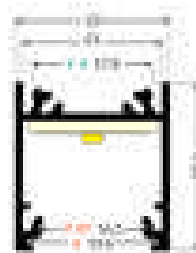
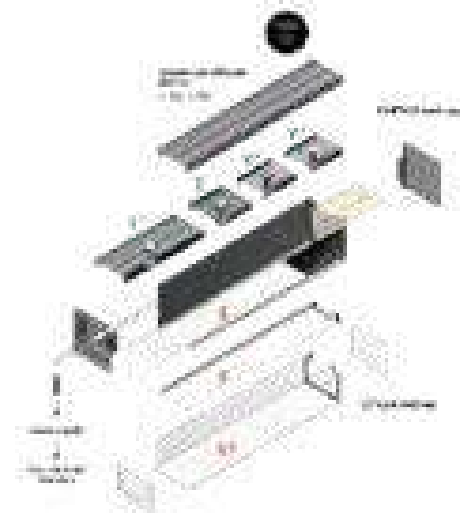

LINEA20 end cap



- white
C1940001
- silver
C1940040
- black
C1940003
- grey
C1940002

LINEA20-E7 end cap



- white
C1999901
- silver
C1999960
- black
C1999902
- grey
C1999903



ACCESSORI

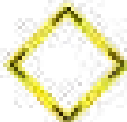

Accessori per led

Accessori per led
 (senza viti, viti e
 fori) - Angolo 60°
 - Per il collegamento
 di due strisce di led
 in un angolo di 60°



Specifiche tecniche

Modello
 Materiale
 Colore
 Dimensioni

Accessori per led
 (senza viti, viti e
 fori) - Angolo 90°
 - Per il collegamento
 di due strisce di led
 in un angolo di 90°



Modello
 Materiale
 Colore
 Dimensioni

Accessori per led
 (senza viti, viti e
 fori) - Angolo 120°
 - Per il collegamento
 di due strisce di led
 in un angolo di 120°



Modello
 Materiale
 Colore
 Dimensioni

Accessori per led
 (senza viti, viti e
 fori) - Angolo 135°
 - Per il collegamento
 di due strisce di led
 in un angolo di 135°



Modello
 Materiale
 Colore
 Dimensioni

Accessori per led
 (senza viti, viti e
 fori) - Angolo 180°
 - Per il collegamento
 di due strisce di led
 in un angolo di 180°



Modello
 Materiale
 Colore
 Dimensioni

Accessori per led
 (senza viti, viti e
 fori) - Angolo 180°
 - Per il collegamento
 di due strisce di led
 in un angolo di 180°



Modello
 Materiale
 Colore
 Dimensioni

Accessori per led
 (senza viti, viti e
 fori) - Angolo 180°
 - Per il collegamento
 di due strisce di led
 in un angolo di 180°



Modello
 Materiale
 Colore
 Dimensioni

PROFILI PER SOFFITTO

74ALP10075-R

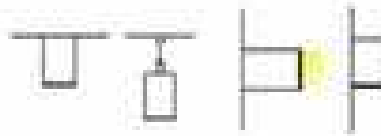
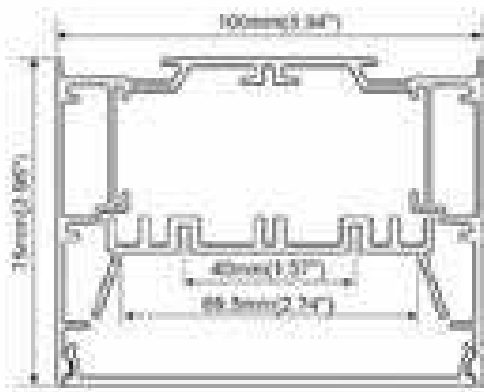
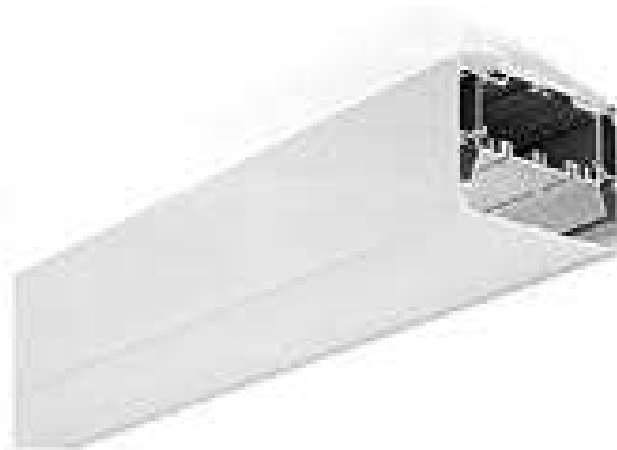

• PC frosted cover



Aluminum End Cap
without hole



Steel wire



Connector L



Internal Clip



Trimless
recessed Clip

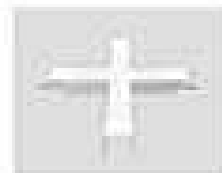

Connector X



Stainless Clip



Connector Y



Connector II

PROFILI PER SOFFITTO

74ALP60108

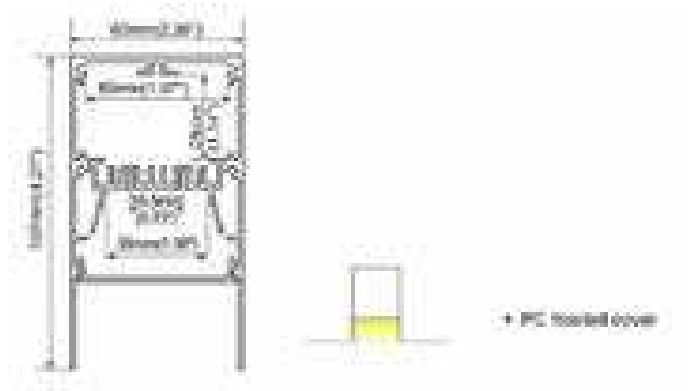

End caps



Outside clip



Internal clip



Steel wire



PROFILI PER SOFFITTO

74ALP75120

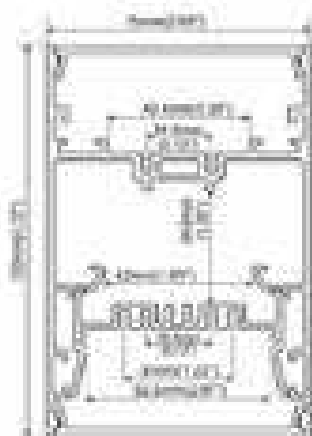

Die cast end caps



Wall clip



Hanging bracket



Inside clip



Steel wire



Safety wire



End cap without hole

748APL052EC0

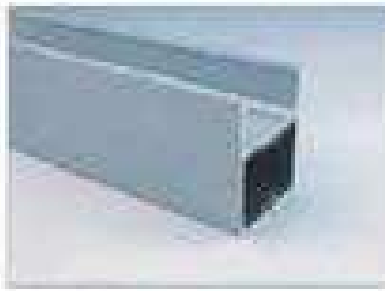

Aluminum profile

748APL052PR



PC diffused cover (milky)
PC semi-clear cover

748APL052ST

748APL052D



Suspension wire(2m)

748APL052SW



180 degree connector

748APL052DC180



90 degree connector

748APL052DC90

PROFILI PER SOFFITTO

74BAPL052

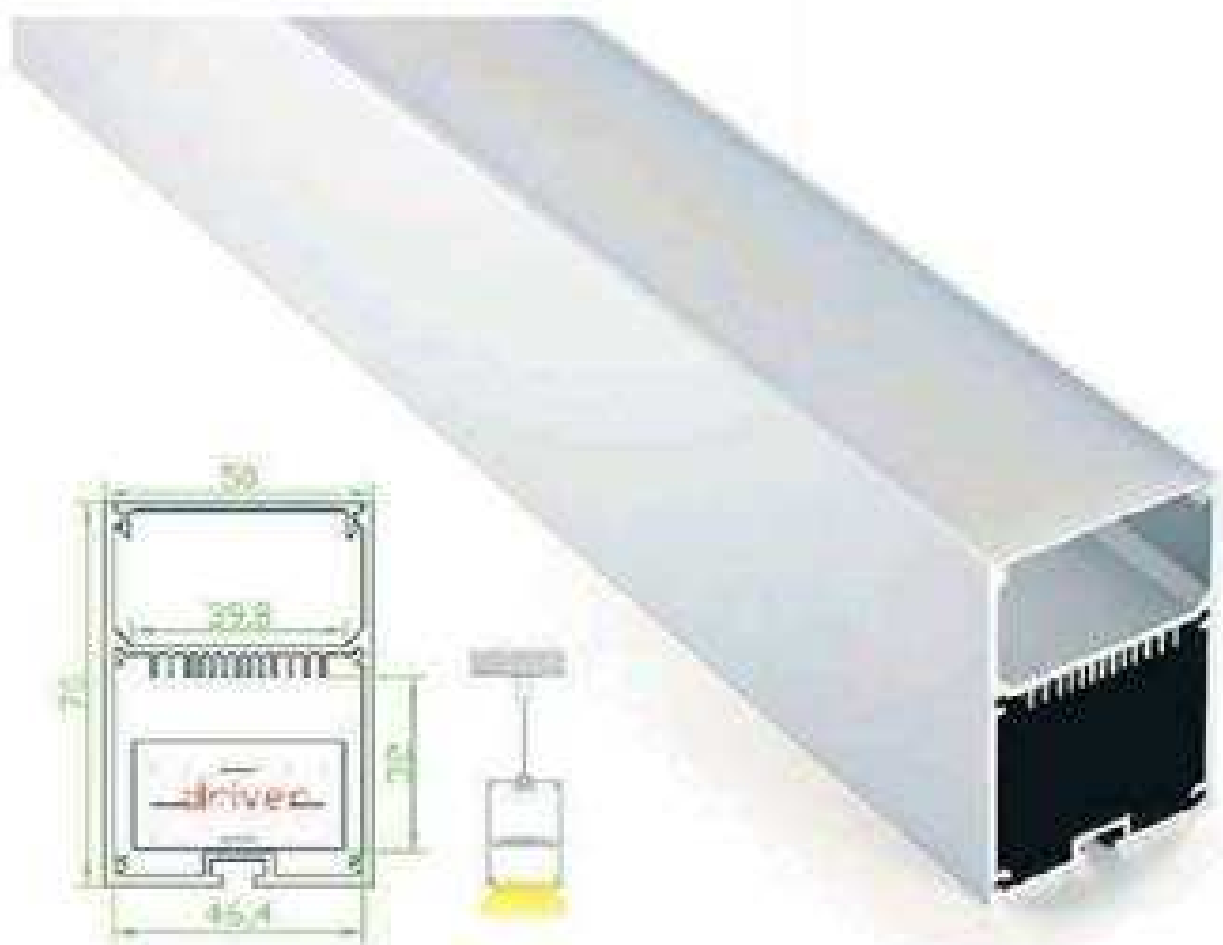

PROFILI PER SOFFITTO

74BAPL056

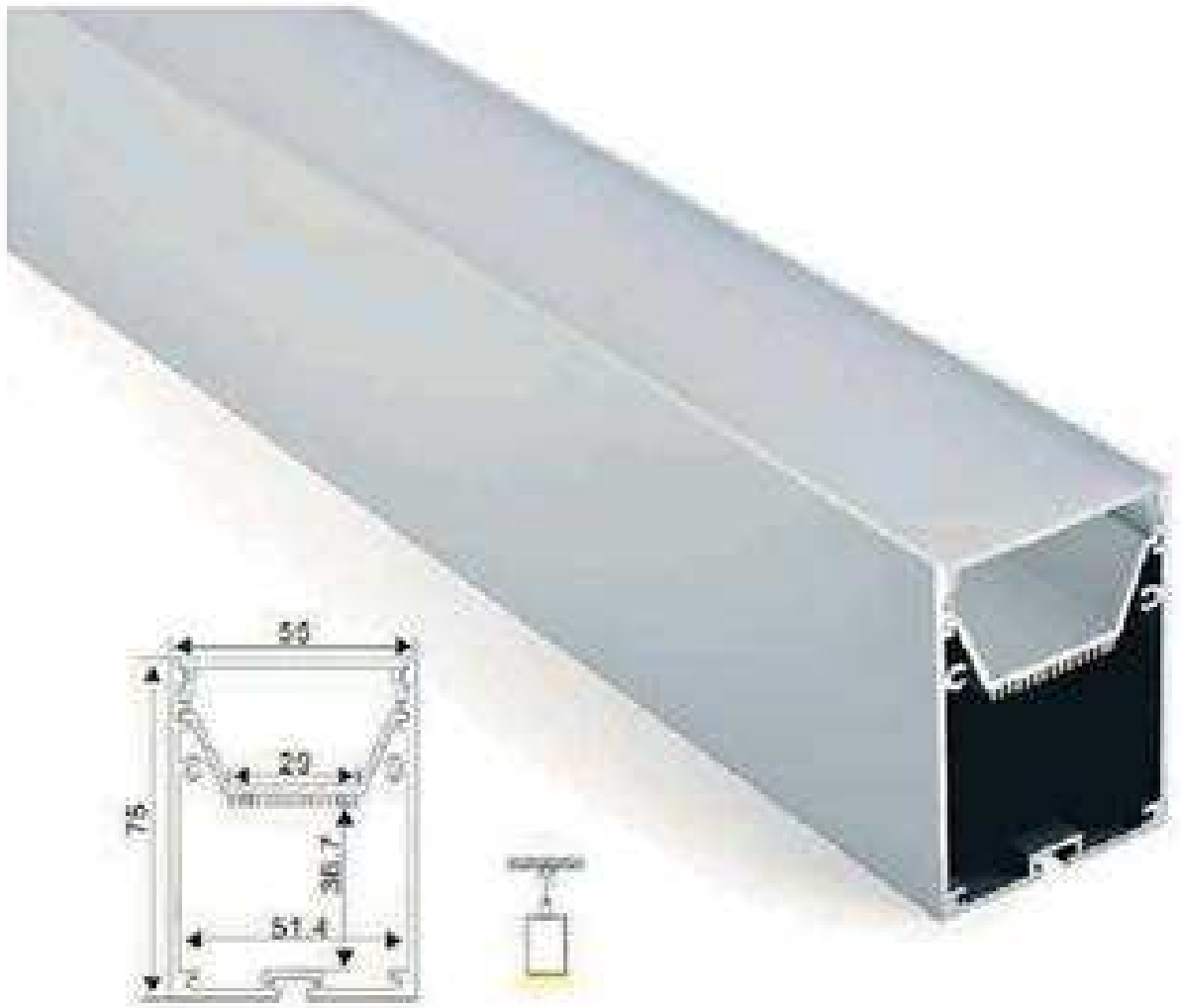

End cap without hole

74BAPL056ECO



Aluminum profile

74BAPL056PR



PC Frosted cover

74BAPL056GH

PROFILI PER SOFFITTO

74BAPL067

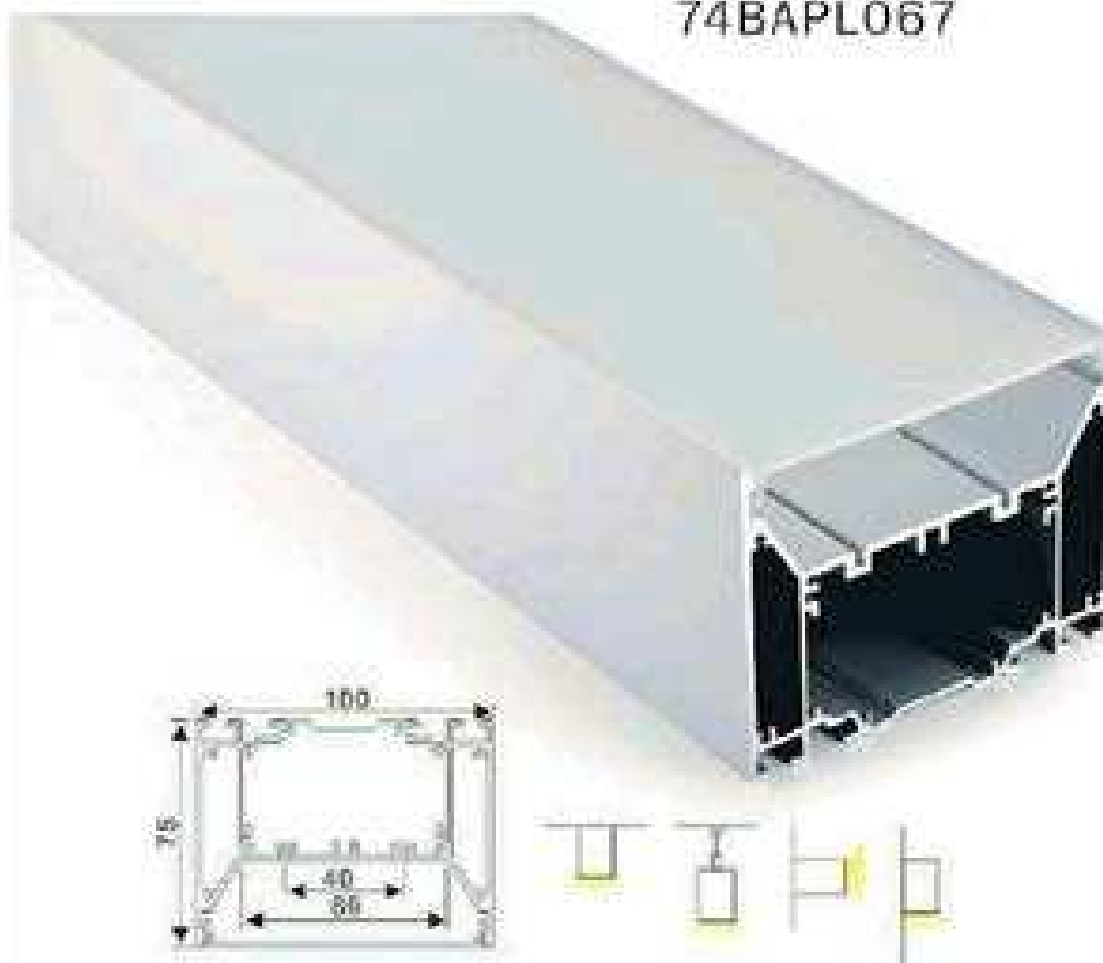

PROFILI PER SOFFITTO

74ALP048R1

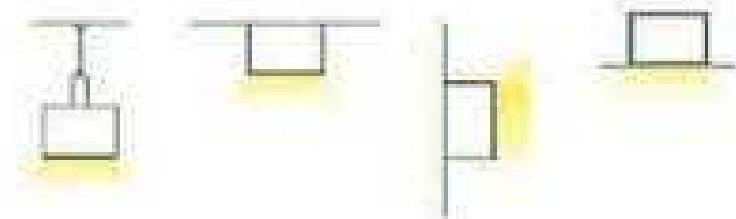

PC diffused cover

74ALP048R1DC



Aluminium End Cap
without hole

74ALP048R1EC0



Aluminium profile

74ALP048R1PR



Stainless Clip

74ALP048R1SC

PROFILI PER SOFFITTO

74ALP048R1D

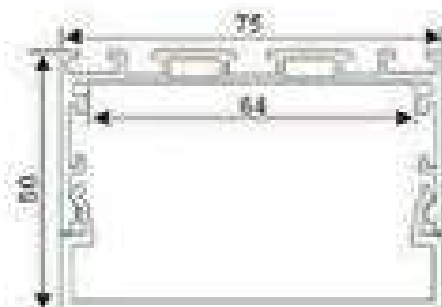
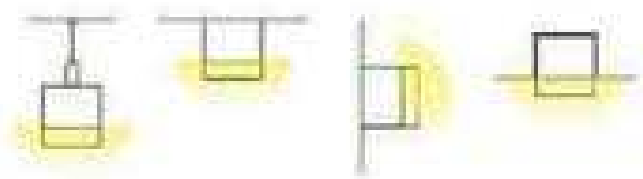

PC Frosted cover

74ALP048R1DGH



aluminium end cap

74ALP048R1DEC



Aluminium profile

74ALP048R1PR



Stainless Clip

74ALP048R1SC



Steel wire

74RAPL052SW



Connector T

74ALP048R1DCT



Connector L

74ALP048R1DCL

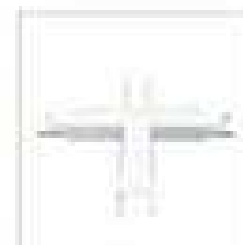

Connector X

74ALP048R1DCX



Connector IL

74ALP048R1DCIL

PROFILI PER SOFFITTO

74BAPL054

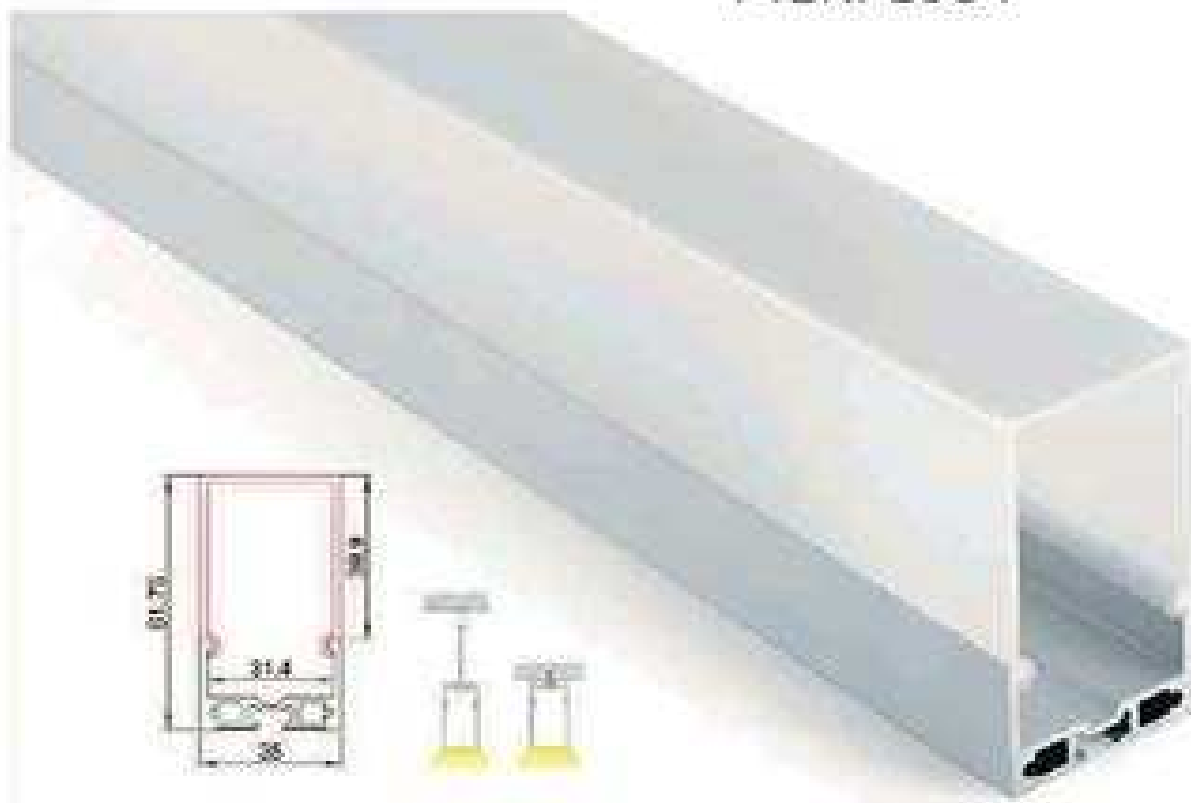

End cap without hole

74BAPL054EC0



Aluminum profile

74BAPL054PR



Suspension wire(2m)

74BAPL052SW

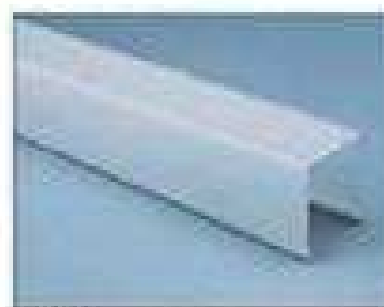

PMMA opal matte cover

74BAPL054O

PROFILI PER SOFFITTO

74BAPL056D

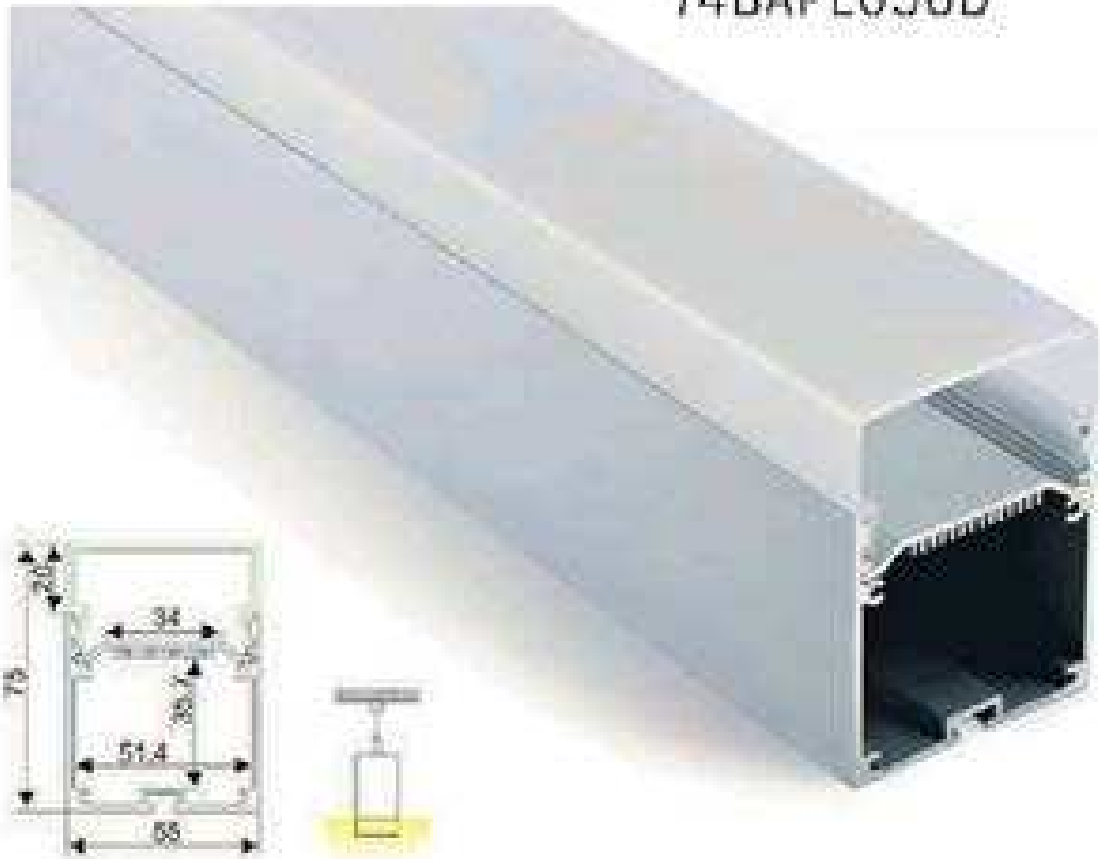

Aluminum profile

74BAPL056DPA



PC Frosted cover

74BAPL056DGH



End cap without hole

74BAPL056ECO



Suspension wire(2m)

74BAPL0525W

PROFILI PER SOFFITTO

74BAPL018



PROFILI PER SOFFITTO

74HL084

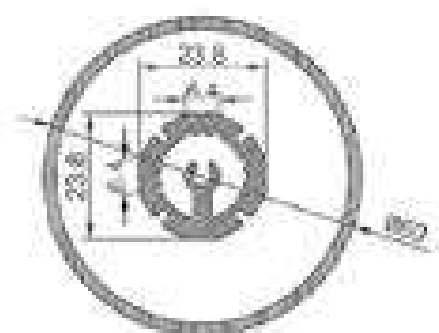

End cap



Aluminum Profile



Screw



Connector



Suspended Profile



Alu Profile+End cap



Cover



PROFILI PER SOFFITTO

74HL084

INSTALLATION METHOD:

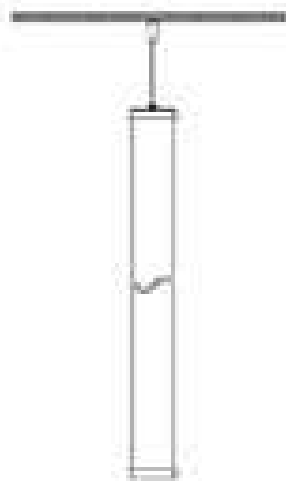

Vertical suspension



Lateral suspension



360 degree light output



PROFILI PER SOFFITTO

74LT60



74LT60

Accessori:



74LT60CN



74LT60CV1



74LT60EC2



74LT60PY

PROFILI PER SOFFITTO

74ALP078

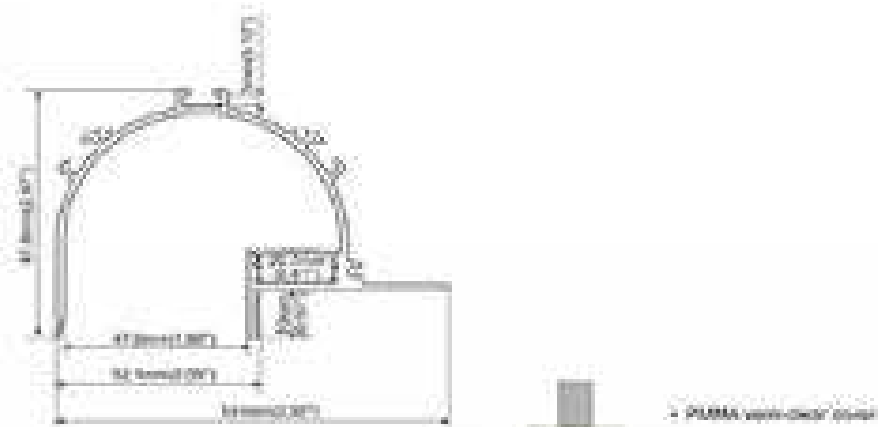

End caps



Clip 1



Clip 2

PROFILI PER SOFFITTO

74BAPL059

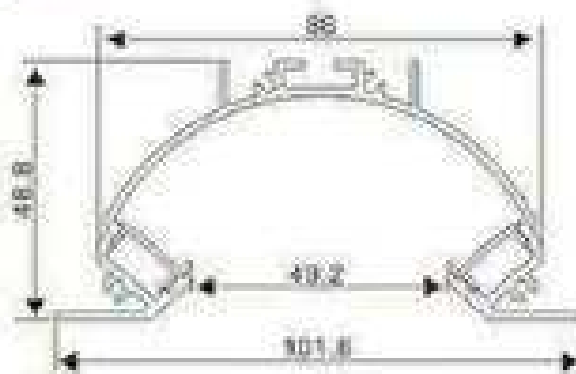



SOLO SU RICHIESTA

PROFILI PER SOFFITTO

74ALP183



Types of installation:



Material: Extruded aluminum

Dimension: 28.3x40mm

Length: MAX 3m

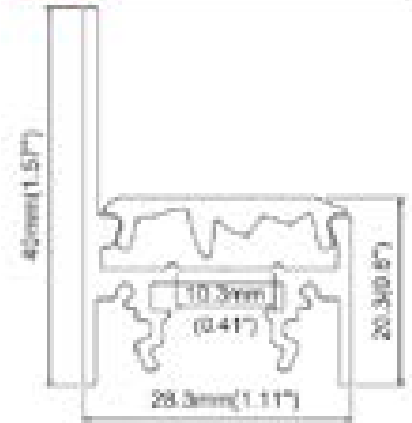

FINISH



Anod. aluminum



white



black

END CAPS



End Caps

ACCESSORIES



Mounting clip (metal)



Spring clip



Lens



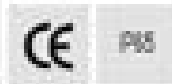

74S18

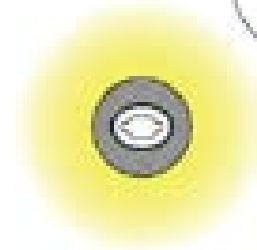
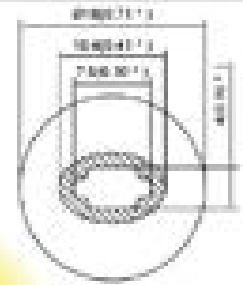

Features

- Made of highly flexible silicone, 360° light emission, matt surface
- Free cutting, minimum cutting distance of 5mm
- Choice of 2 color temperatures (3000K/4000K)
- 14w/m, 850Lm/W, indoor use, 24V

END CAPS



Surface

DIFFUSERS



Vertical ceiling surface



Channel surface

ACCESSORIES



Clip



Steel wire

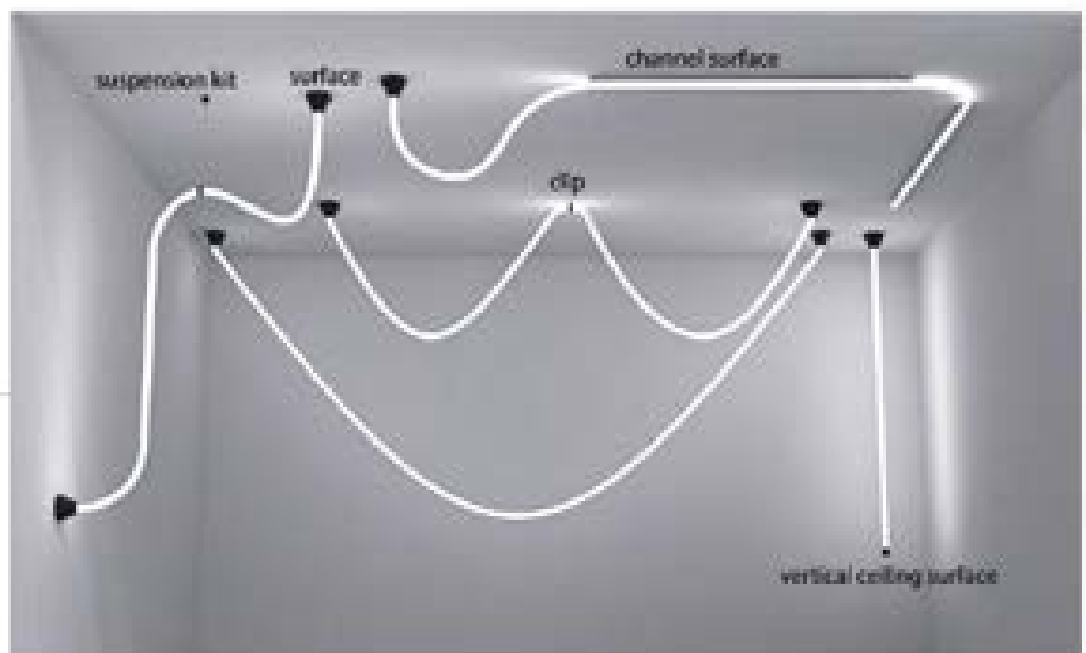

PROFILI PER SOFFITTO



Aluminium profile

74BAPL059PR



PMMA opal matte cover
PMMA semi-clear cover
PC diffused cover

74BAPL0590

74BAPL059S1

74BAPL059D



Aluminium end cap

74BAPL059EC0



Spring Clip

74BAPL0595C

PROFILI PER SOFFITTO

74ALP111-R



End cap



Cap

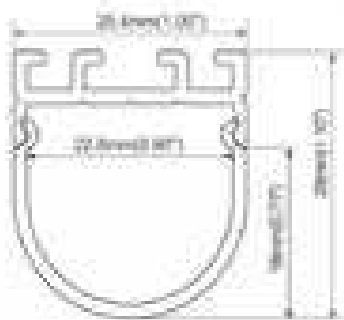

• PC diffused cover

PROFILI PER CARTONGESSO

74ALP3535U

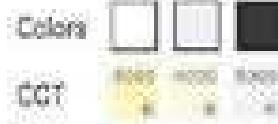

Material:
Surface Processing:
Insulation:
Size:
Application:

Alu6063-T5/PC Opal-Diffuser/End cap
Anodization/Powder coating
Recessed
58.8 (width) x 59.3 (height) x 2560 (length) mm
Indoor



AL-VS-3535U



PC-VS-3535U



EC-VS-3535U

Types of installation:



Material: Extruded aluminum
Dimension: 39.6×24.4mm
Length: MAX 3m
Compatible with 12.5mm drywall

74ALP129-I

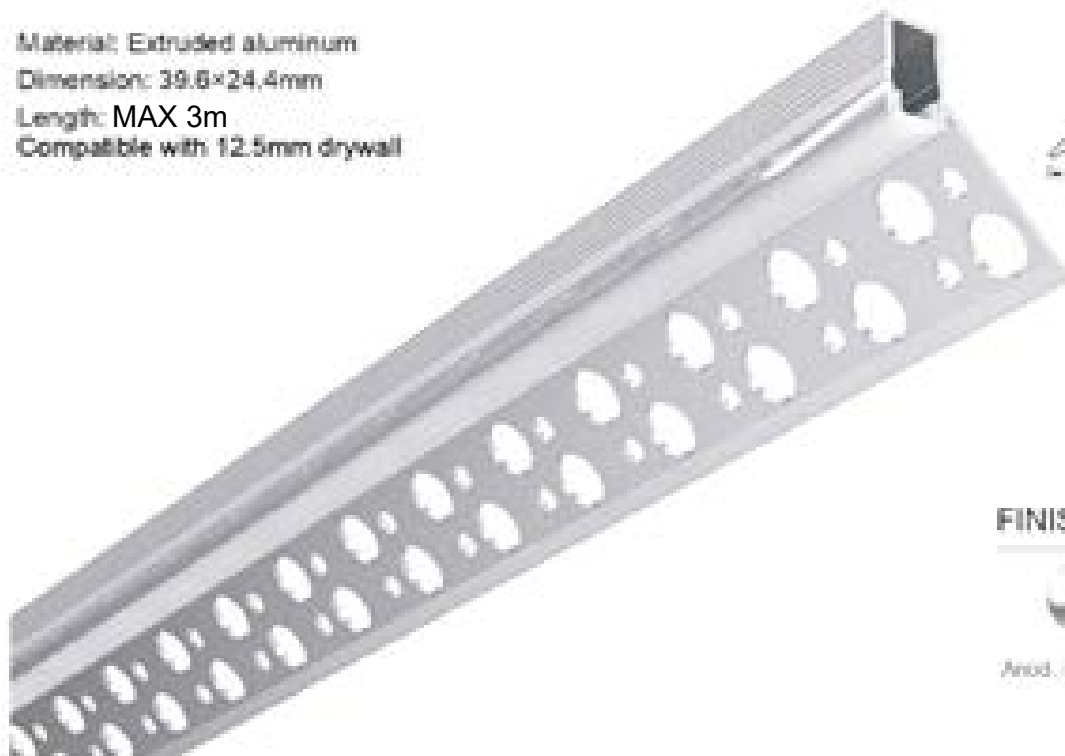
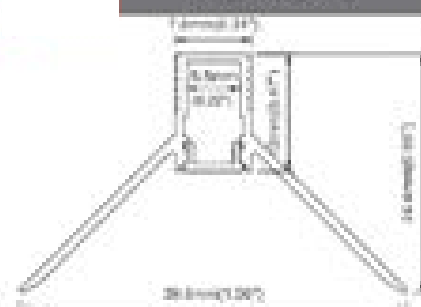

FINISH



END CAPS

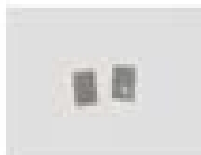

End cap with hole
End cap without hole

DIFFUSERS



PC frosted

ACCESSORIES



Disposable cover

74OMNI10

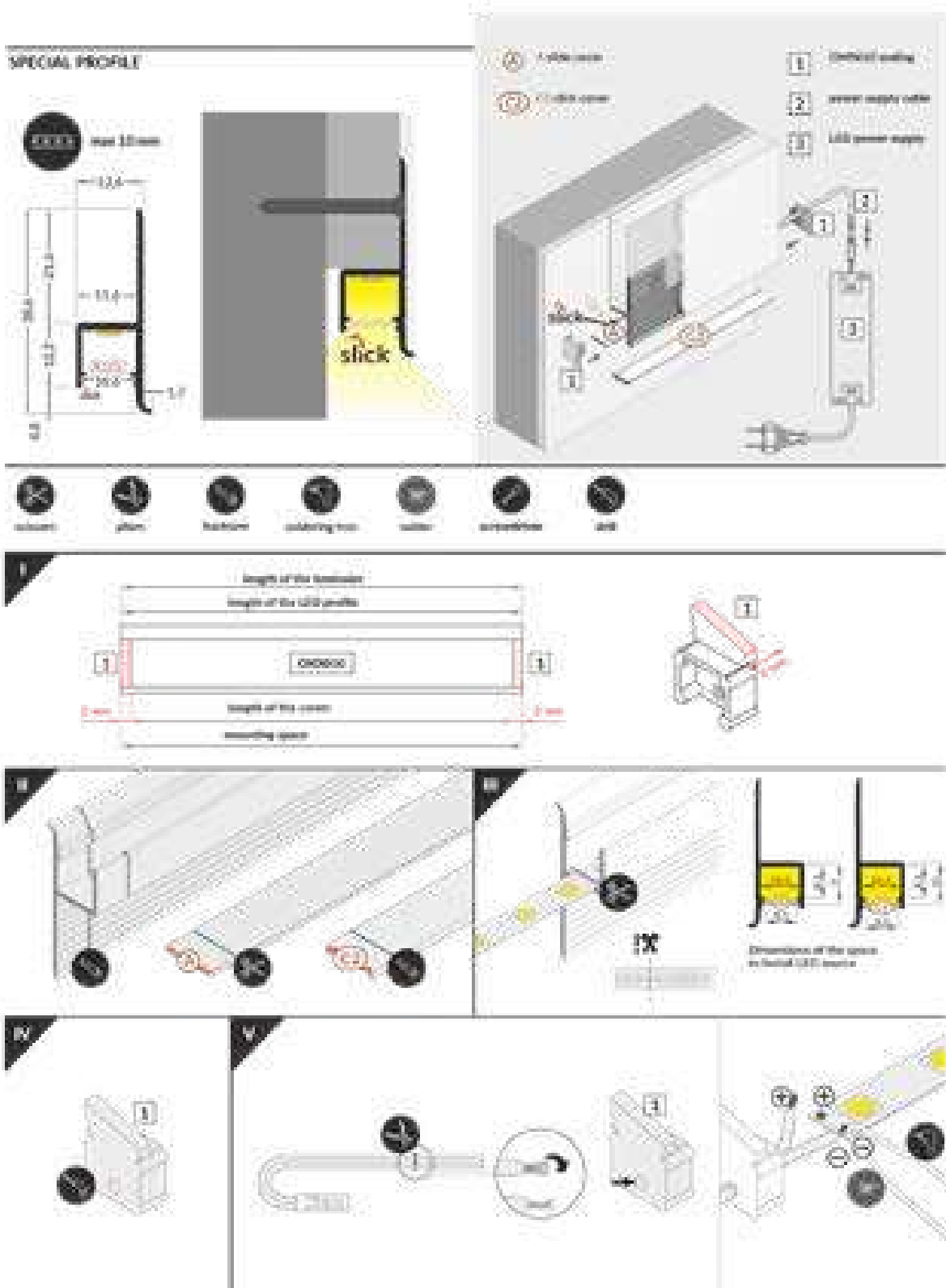

PROFILI PER CARTONGESSO

74ALP068

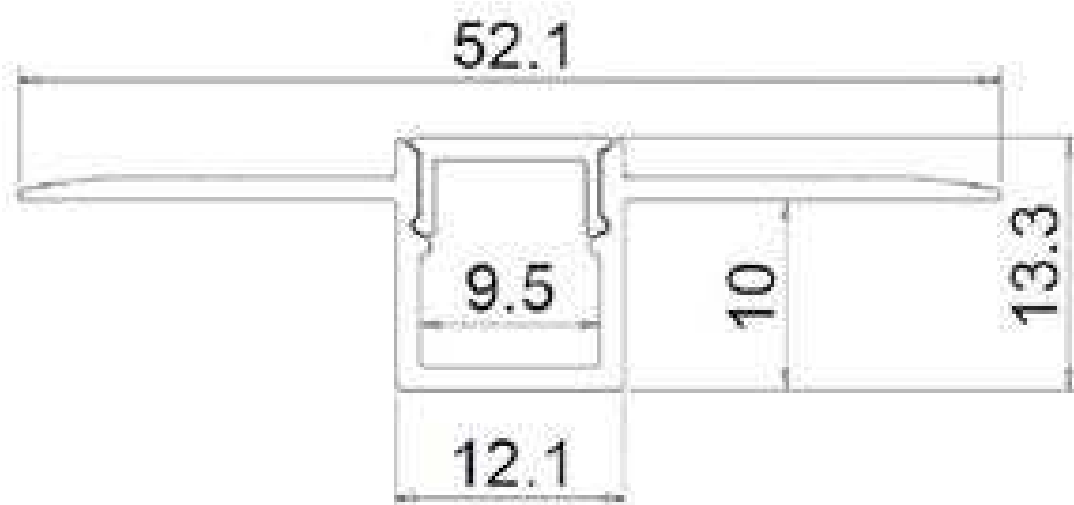

PROFILI PER CARTONGESSO

74ALP079

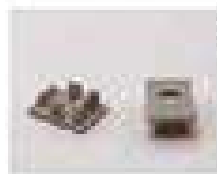
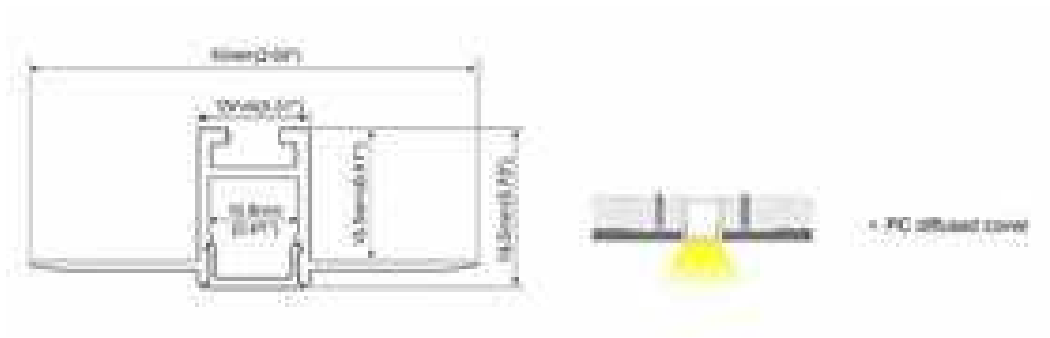
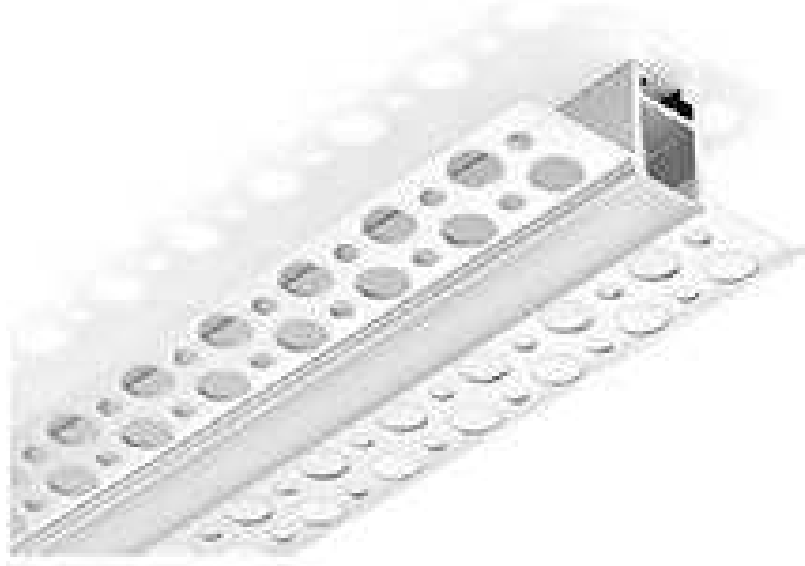

End caps

PROFILI PER CARTONGESSO

74ALP069

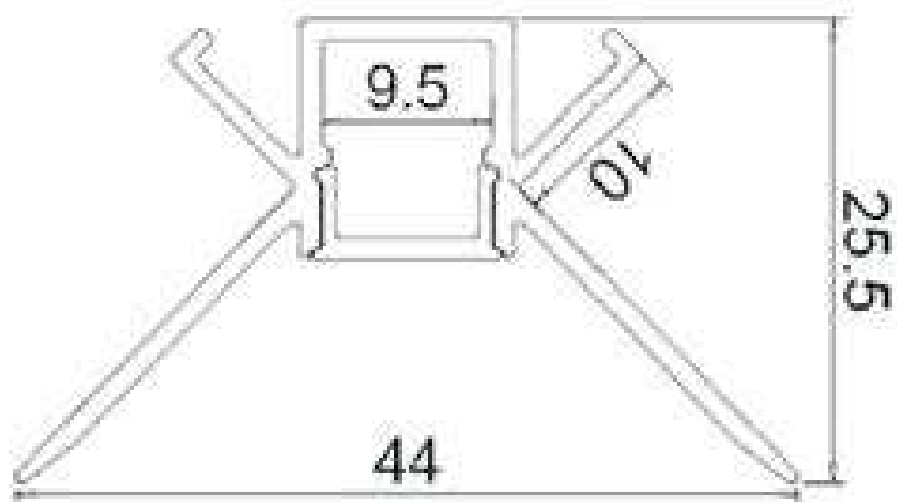

PROFILI PER CARTONGESSO

74ALP070

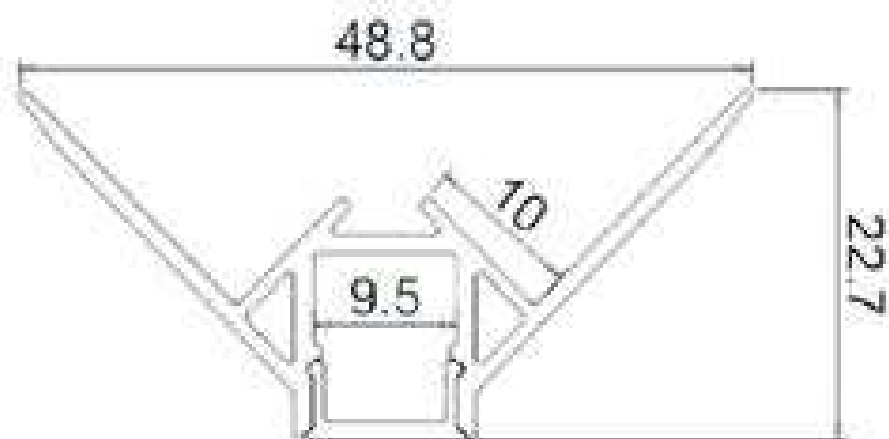

74ALP071

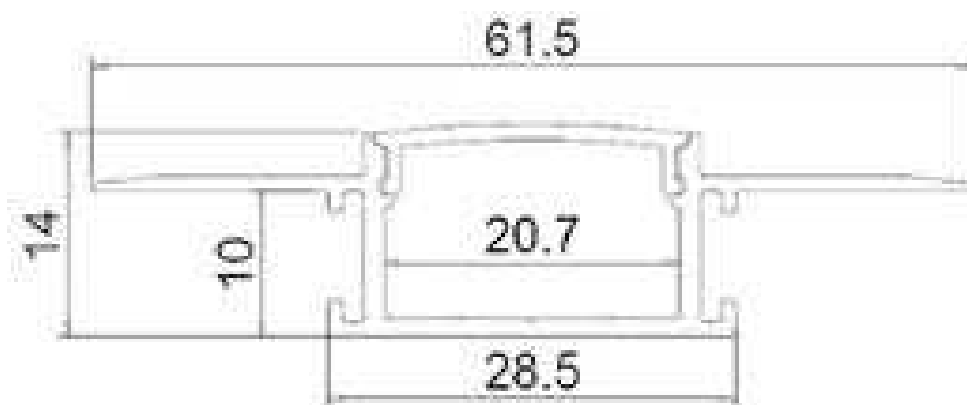
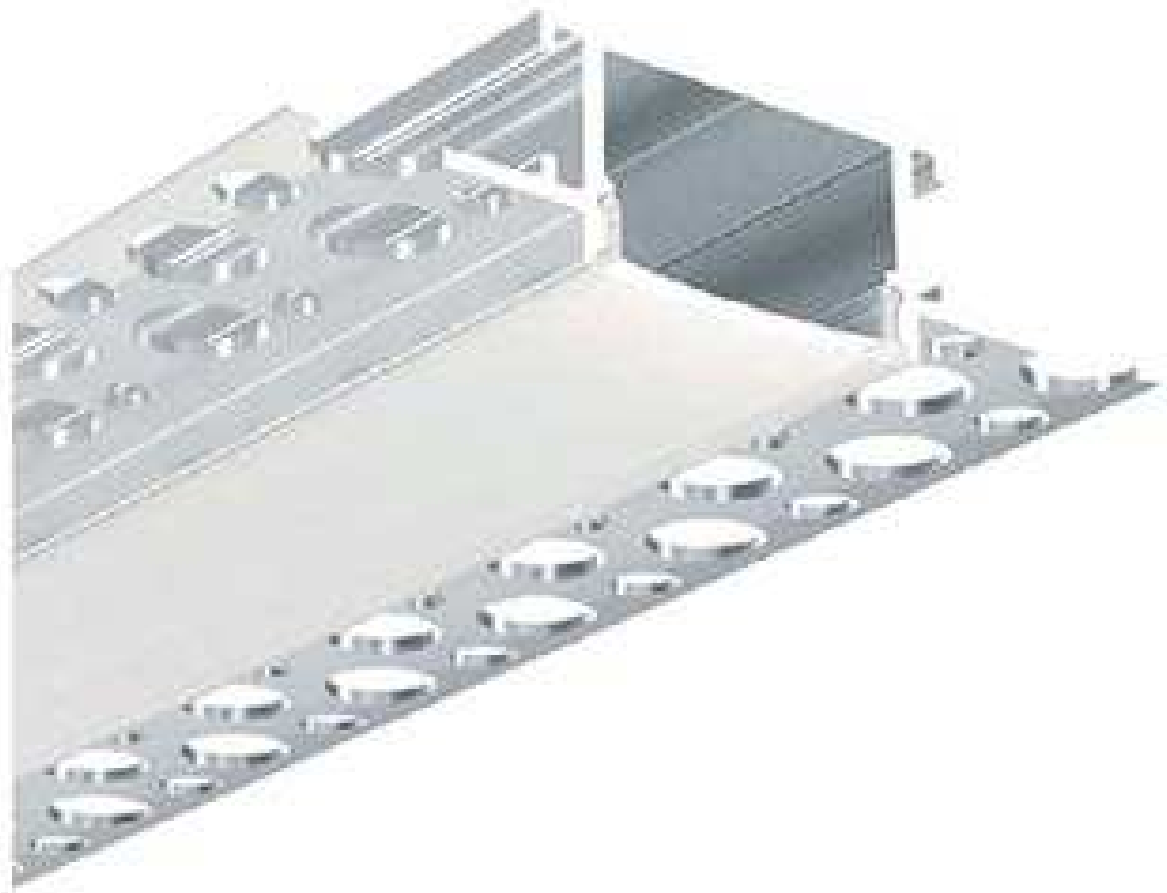

PROFILI PER CARTONGESSO

74ALP080

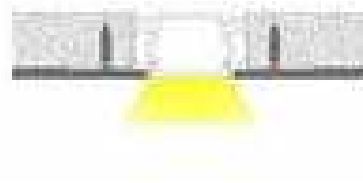
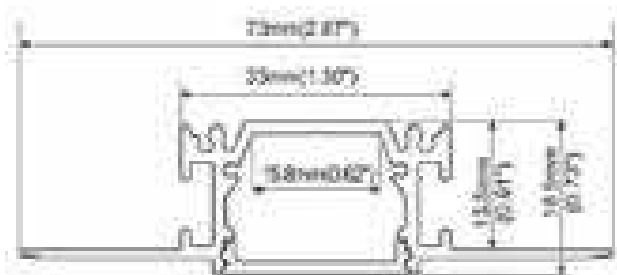
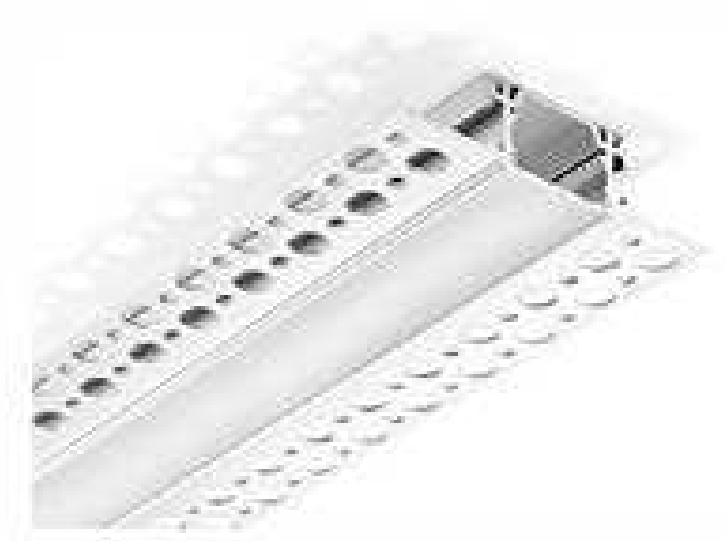

• PC diffused cover



End caps

PROFILI PER CARTONGESSO

74ALP082

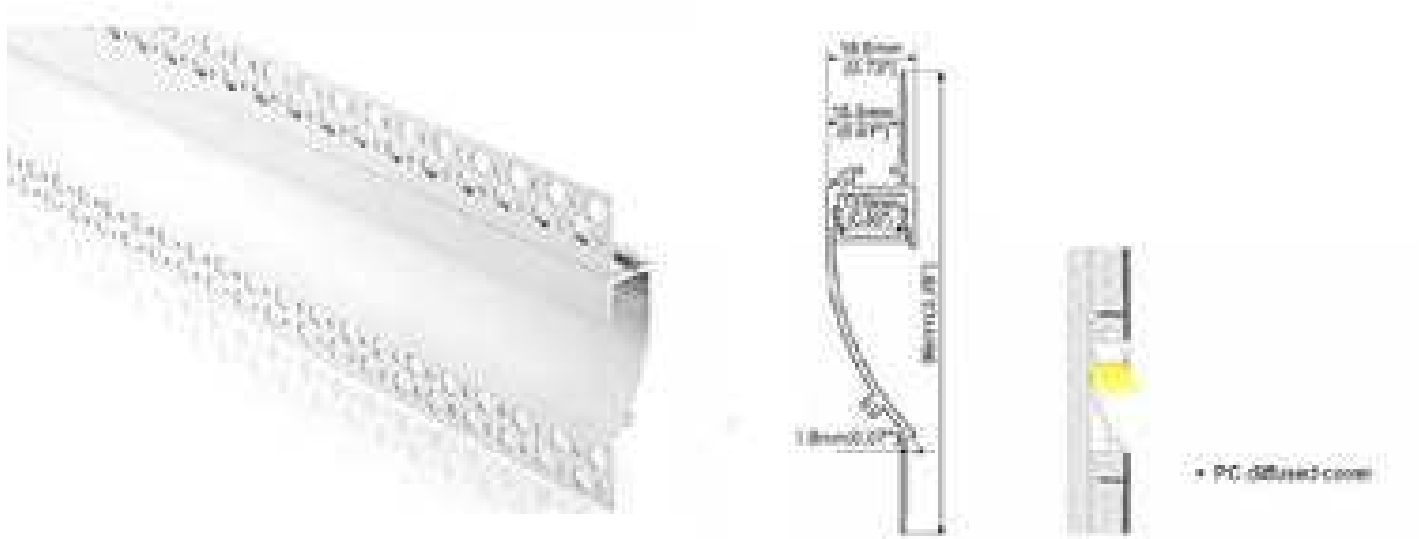

End caps



PROFILI PER CARTONGESSO

74HL062

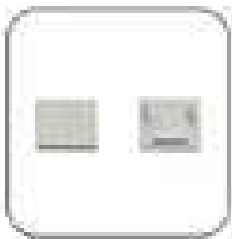
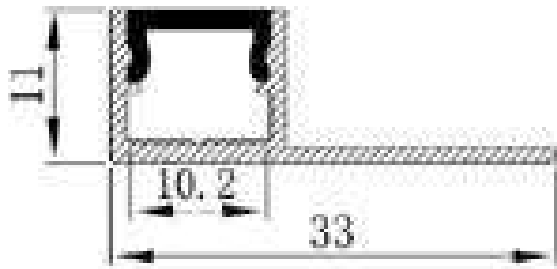

End cap



Aluminum Profile



Alu Profile (Back)



Cover



PROFILI PER CARTONGESSO

74HL062

INSTALLATION 1:

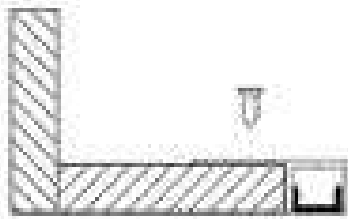

Step1

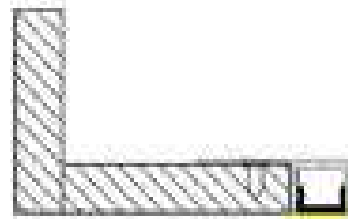

Step2

INSTALLATION 2:



Step1

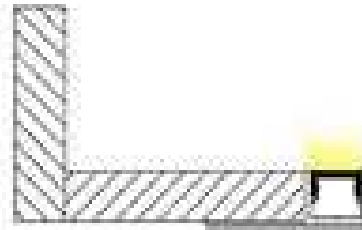

Step2

APPLICATION



PROFILI PER CARTONGESSO

74ALP090

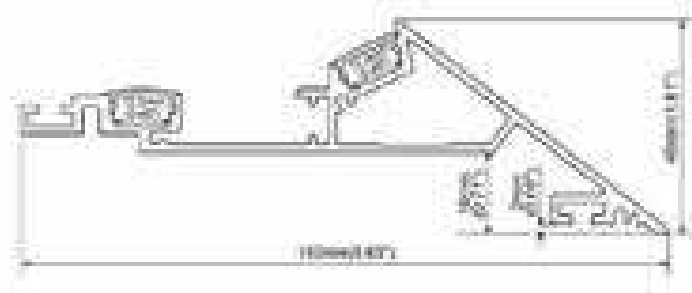
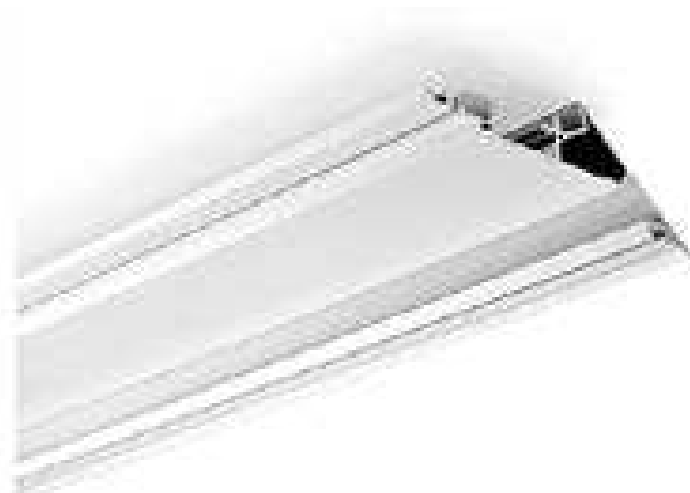

End caps

PMMA semi-clear cover

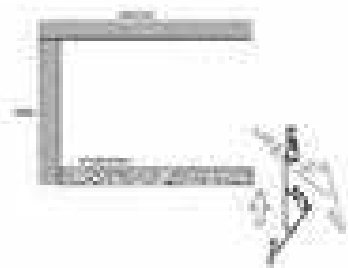

Step 01



Step 02

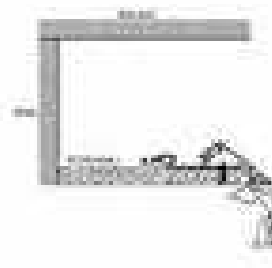

Step 03



Step 04

74ALP128



- IPC diffused cover
- PC semi clear cover



End cap

PROFILI PER CARTONGESSO

74ALP126

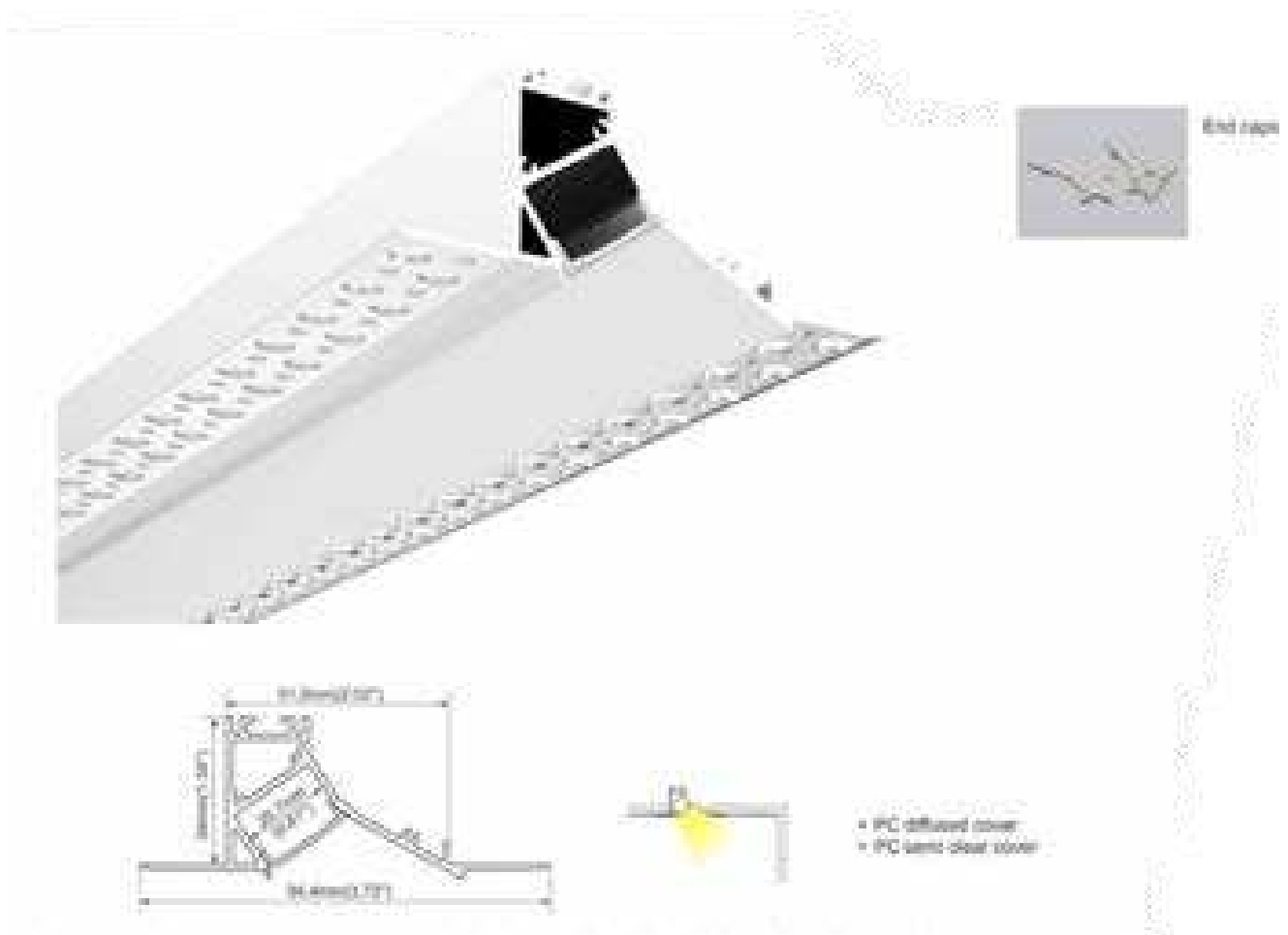

74ALP129

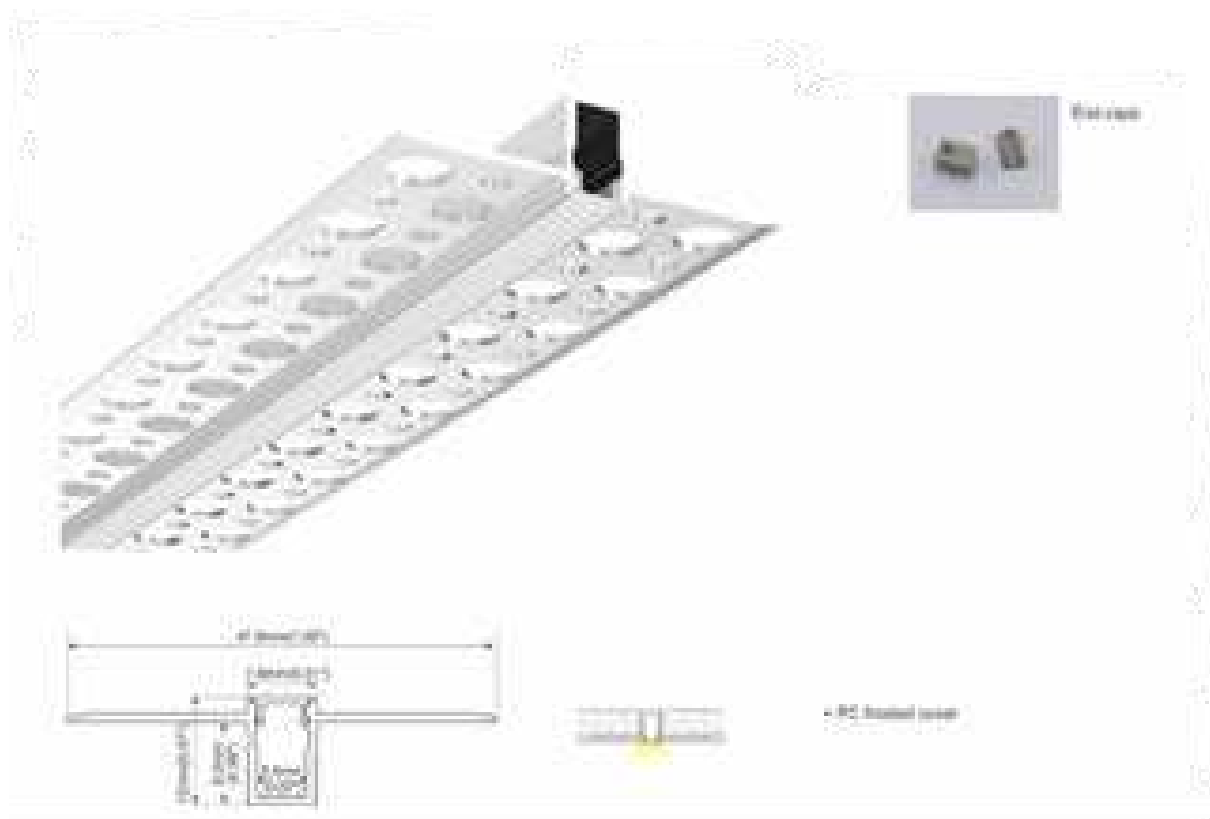

PROFILI PER CARTONGESSO

74ALP110-R

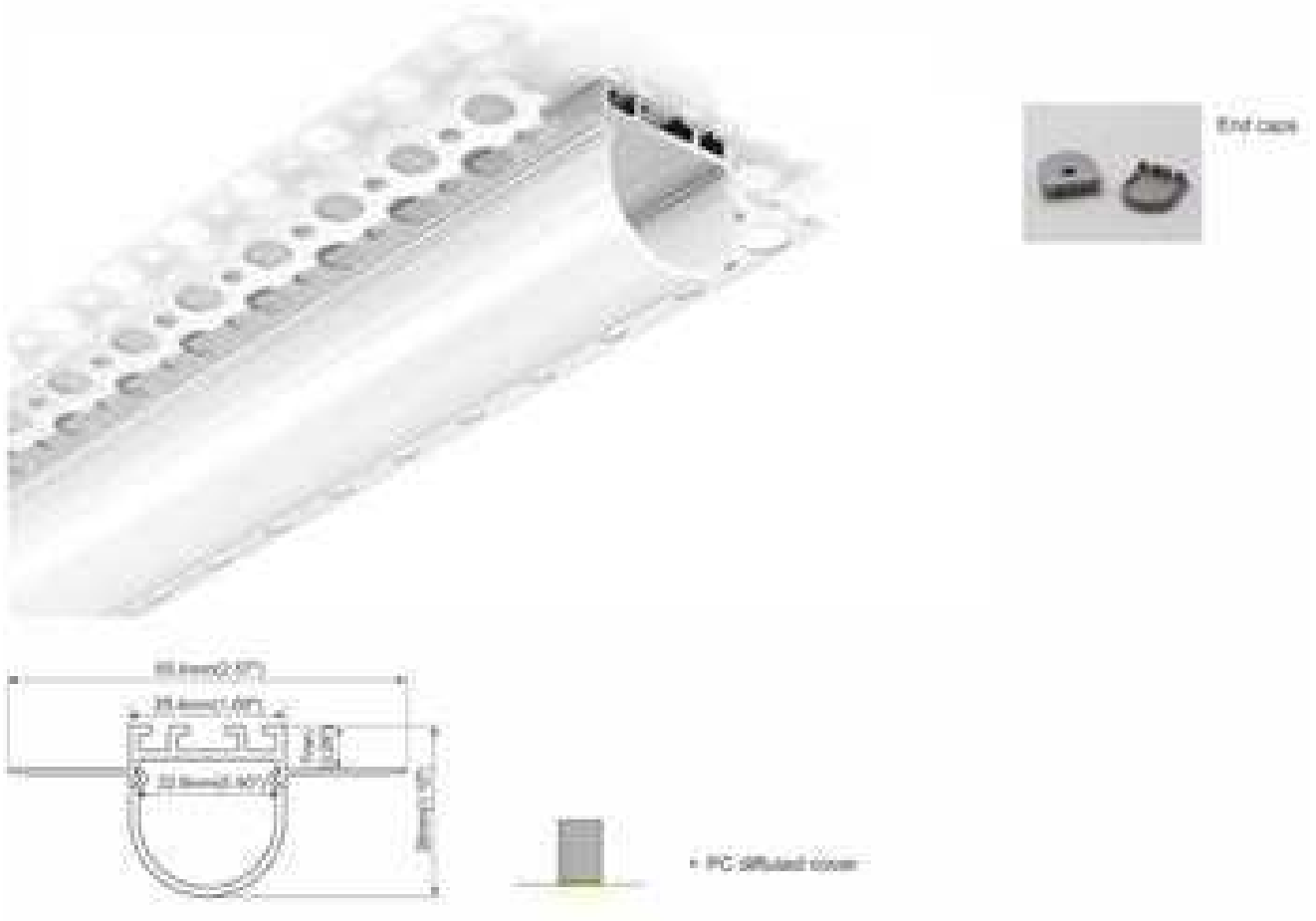

PROFILI PER CARTONGESSO

74ALP110-S

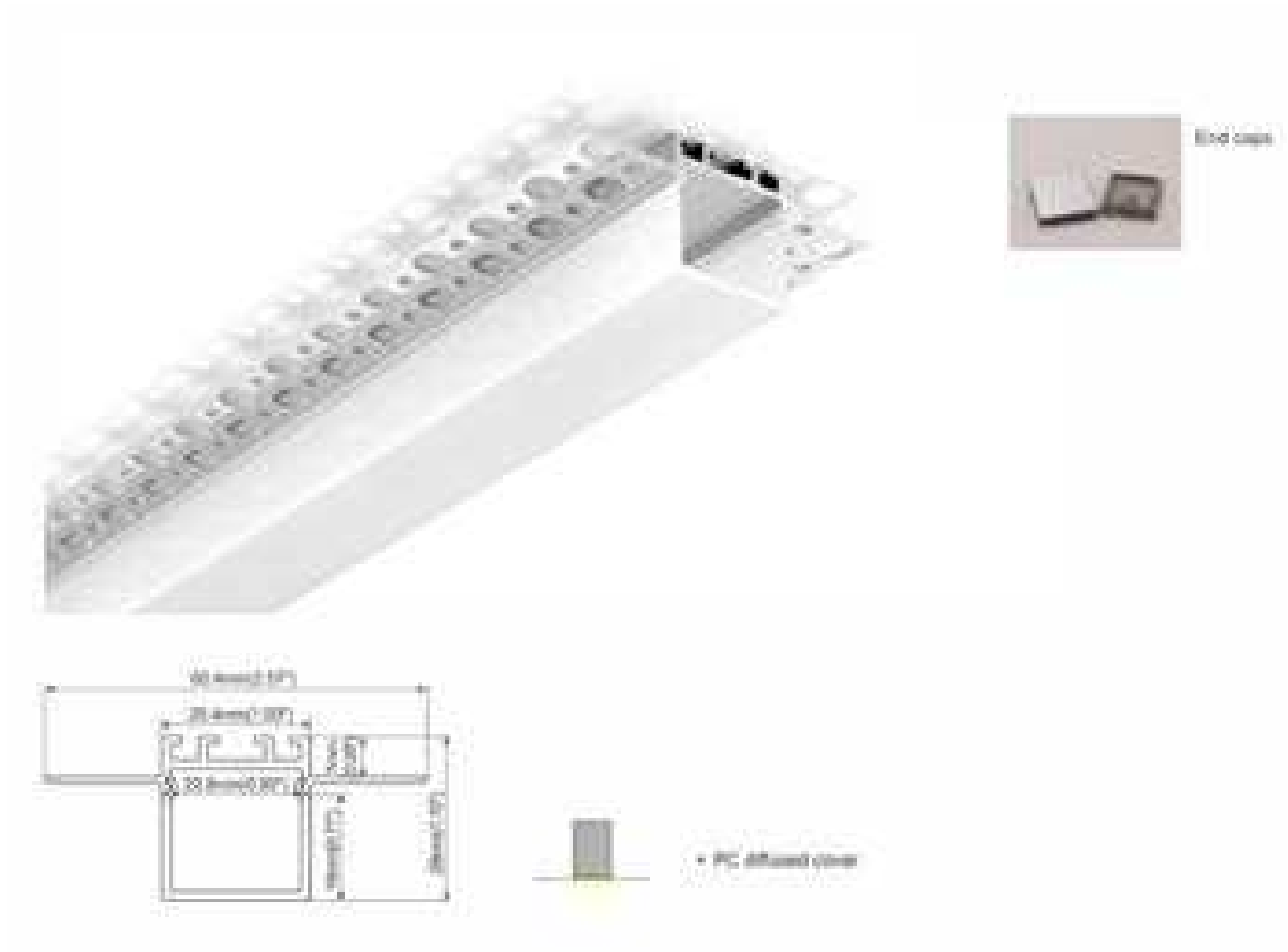



SOLO SU RICHIESTA

PROFILI PER CARTONGESSO

Types of installation:



74ALP159-TR



Material: Extruded aluminum
Dimension: 40.7x51mm
Length: MAX 3m
Compatible with 12.5mm drywall

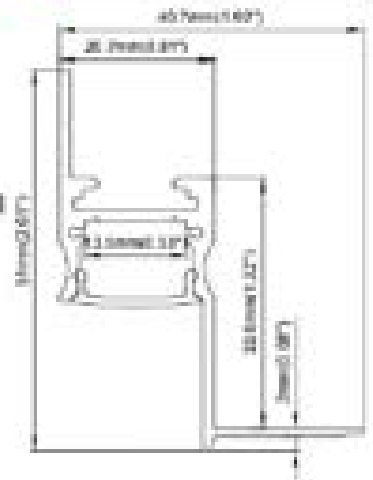

P2I

FINISH



Anod aluminum



White



Black

END CAPS



End cap with hole
End cap without hole

DIFFUSERS



PC diffused



Prismatic

ACCESSORIES



90° Horizontal connector



180° Connector



Disposable cover





SOLO SU RICHIESTA

PROFILI PER CARTONGESSO

Types of installation:



Material: Extruded aluminum
Dimension: 42.2x48.1mm
Length: MAX 3m
Compatible with 12.5mm drywall



74ALP159-TR1

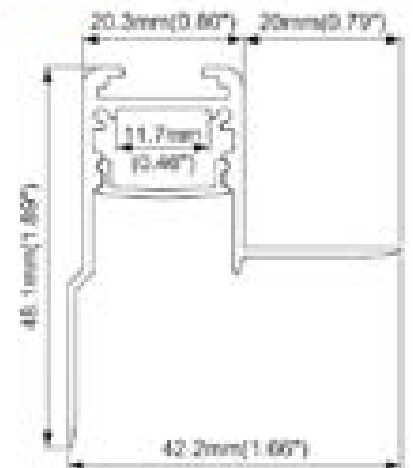

F20

FINISH



Anod. aluminum



White



Black

END CAPS



End cap with hole
End cap without hole

DIFFUSERS



PC diffused



Prismatic

ACCESSORIES



90° Horizontal connector



180° Connector



Disposable cover



SOLO SU RICHIESTA

PROFILI PER CARTONGESSO

74ALP168

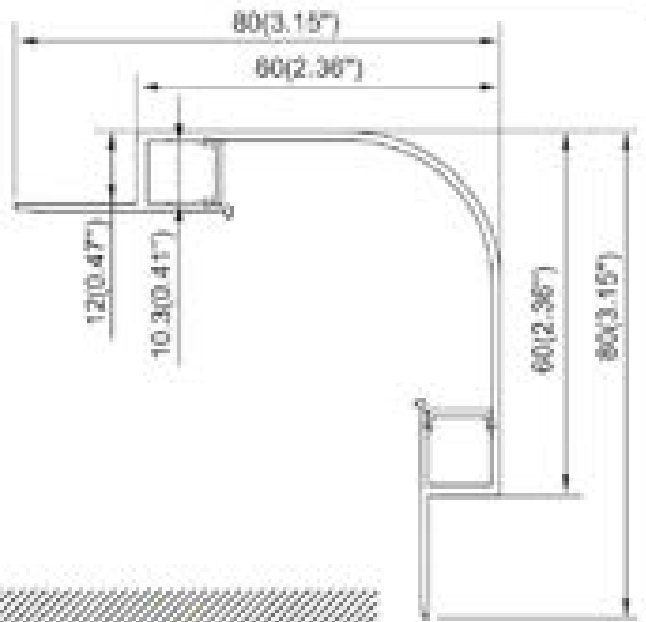

Types of installation:



Material: Extruded aluminum
Dimension: 80x80mm
Length: MAX 3m
Compatible with 12.5mm drywall

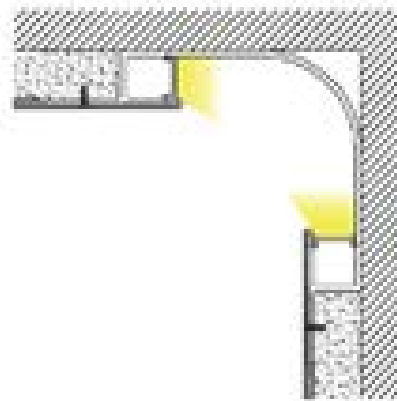

FINISH



Anod. aluminum

white

black

END CAPS



End cap with hole
End cap without hole

DIFFUSERS



PC diffused

ACCESSORIES



Disposable cover



SOLO SU RICHIESTA

PROFILI PER CARTONGESSO

Types of installation:



74ALP171

Material: Extruded aluminum
Dimension: 60.3x13.1mm
Length: MAX 3m
Compatible with 12.5mm drywall

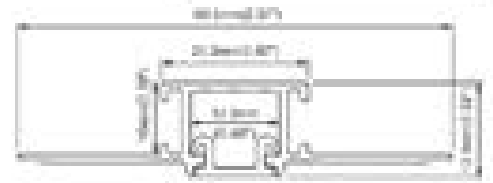

P20

END CAPS



End cap with hole
End cap without hole

FINISH



Anod. aluminum



white



Black

DIFFUSERS



PC diffused



Black diffused

ACCESSORIES



90° Horizontal connector



90° Vertical connector



180° Connector



Types of installation:



Material: Extruded aluminum

Dimension: 75x13,1mm

Length: MAX 3m

Compatible with 12.5mm drywall

74ALP172



END CAPS



End Caps

FINISH



Anod. aluminum



white



Black

DIFFUSERS



PC diffused



Black diffused

ACCESSORIES



90° Horizontal connector



90° Vertical connector



180° Connector



Types of installation:



Material: Extruded aluminum
Dimension: 47.8x12mm
Length: MAX 3m
Compatible with 12.5mm drywall

74ALP129

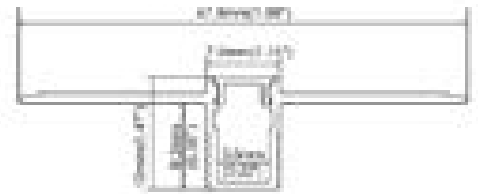

FINISH



END CAPS

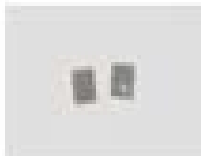

End cap with hole
End cap without hole

DIFFUSERS

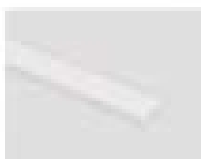

PC frosted

ACCESSORIES



Disposable cover



SOLO SU RICHIESTA

PROFILI PER CARTONGESSO

Types of installation:



Material: Extruded aluminum
Dimension: 44.1x22.3mm
Length: MAX 3m
Compatible with 12.5mm drywall

74ALP129-O

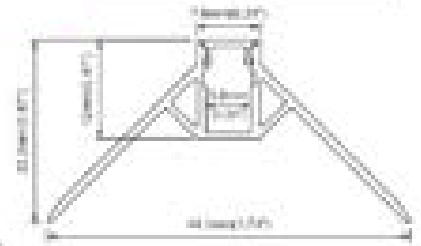

FC

FINISH



Anod. aluminum



White



Black

END CAPS



End cap with hole
End cap without hole

DIFFUSERS



PC frosted

ACCESSORIES

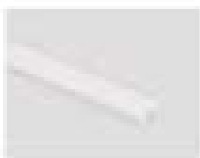

Disposable cover



SOLO SU RICHIESTA

PROFILI PER CARTONGESSO

Types of installation:



Material: Extruded aluminum
Dimension: 49x34.9mm
Length: MAX 3m
Compatible with 12.5mm drywall



74ALP071-S

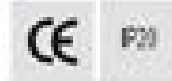
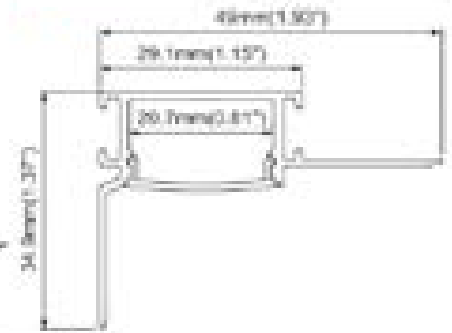

FINISH



END CAPS



End cap with hole
End cap without hole

DIFFUSERS



PC diffused

ACCESSORIES



90° Horizontal connector

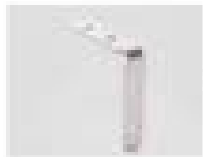

90° Vertical connector



180° Connector



Disposable cover





SOLO SU RICHIESTA

PROFILI PER CARTONGESSO

Types of installation:



Material: Extruded aluminum

Dimension: 88x23.7mm

Length: MAX 3m

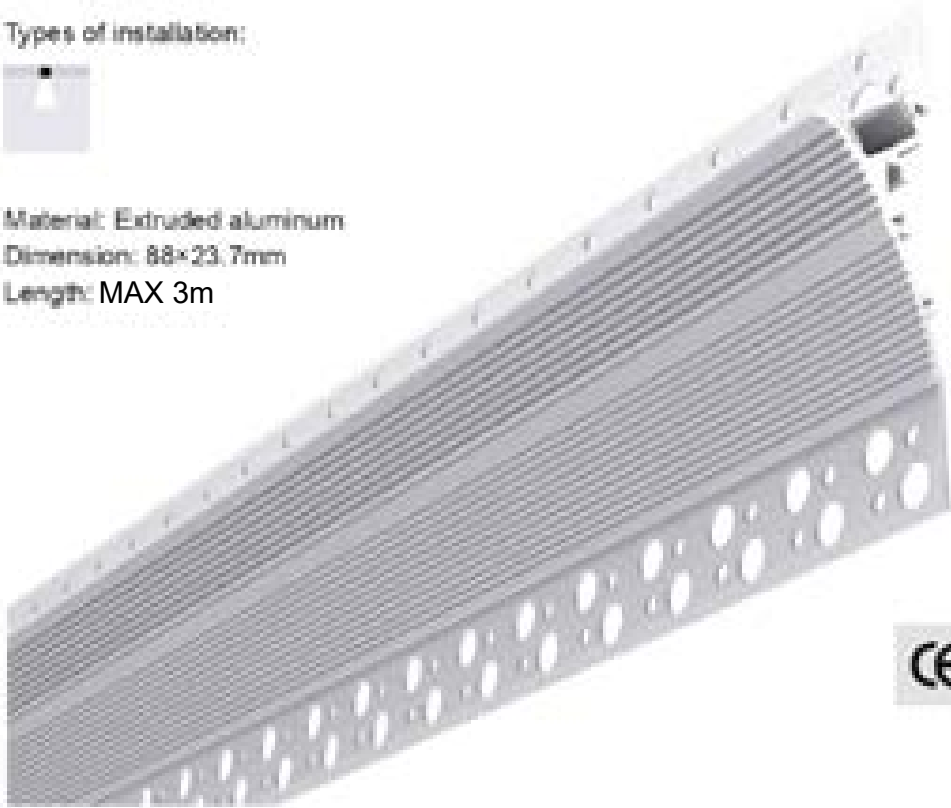

74ALP128-R

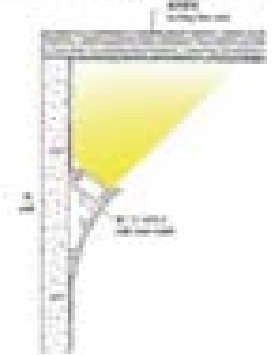

FINISH



white

END CAPS

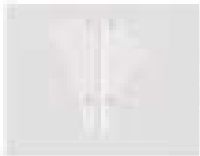

End Caps

DIFFUSERS



PC diffused

ACCESSORIES



90° Horizontal connector



90° Vertical connector



180° Connector



Disposable cover





74ALP128



Types of installation:



Material: Extruded aluminum
Dimension: 35x95.7mm
Length: MAX 3m
Compatible with 15mm drywall



FINISH



white

END CAPS



End Caps

DIFFUSERS



PC diffused

ACCESSORIES



Disposable cover





SOLO SU RICHIESTA

PROFILI PER CARTONGESSO

Types of installation:



Material: Extruded aluminum
Dimension: 14.8x38.5mm
Length: MAX 3m
Compatible with 12.5mm drywall

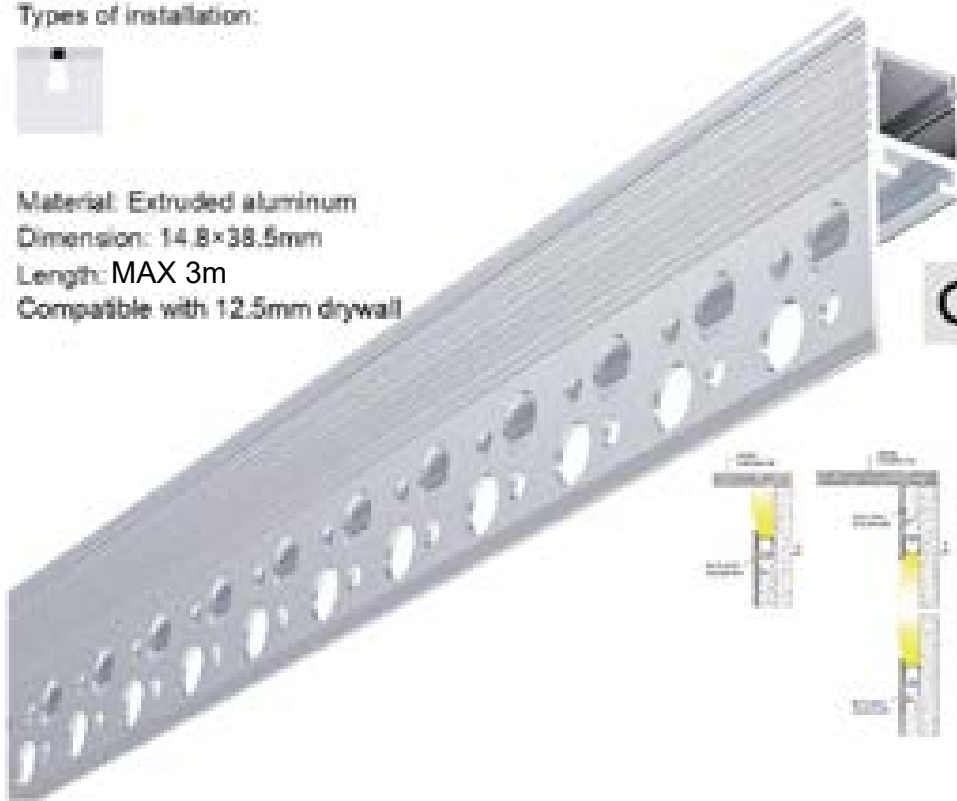

74ALP185

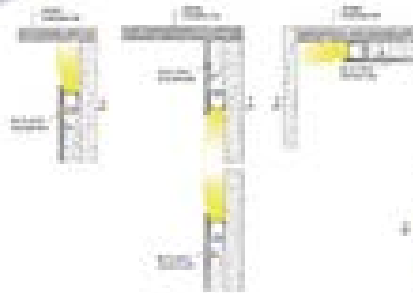
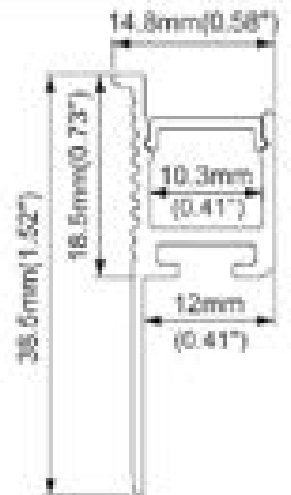

FINISH



END CAPS



End Caps

DIFFUSERS

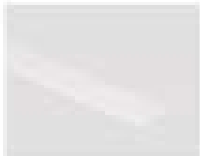

PC diffused

ACCESSORIES



90° Horizontal connector



90° Vertical connector



180° Connector

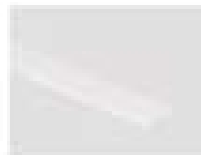

Disposable cover





SOLO SU RICHIESTA

PROFILI PER CARTONGESSO

Types of installation:



Material: Extruded aluminum

Dimension: 35.9x60mm

Length: MAX 3m



74ALP189

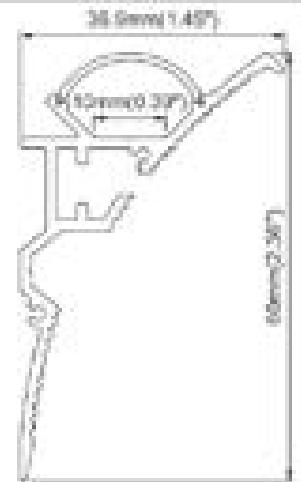

P20

FINISH



white

END CAPS

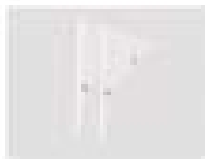

End Caps

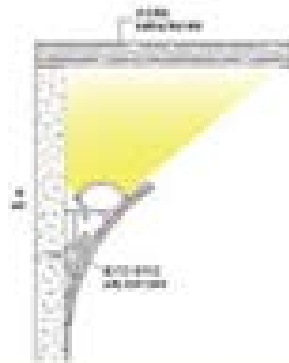

DIFFUSERS



PC diffused

ACCESSORIES



90° Horizontal connector



90° Vertical connector



180° Connector





74ALP070-V

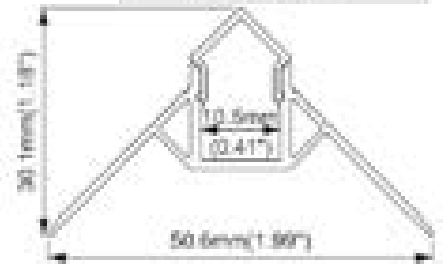

Types of installation:



Material: Extruded aluminum
Dimension: 50.6x30.1mm
Length: MAX 3m
Compatible with 12.5mm drywall



P20

FINISH



Brushed aluminum



White



Black

END CAPS



End cap with hole
End cap without hole

DIFFUSERS



PC diffused

ACCESSORIES

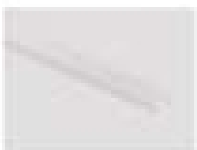

Disposable cover



SOLO SU RICHIESTA

PROFILI PER CARTONGESSO

Types of installation:



Material: Extruded aluminum
Dimension: 63x26.2mm
Length: MAX 3m
Compatible with 12.5mm drywall



74ALP177

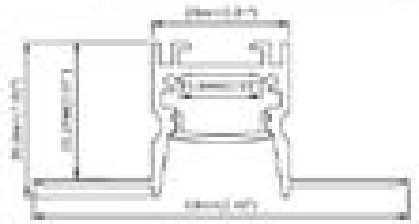

P20

FINISH



Anod aluminum



White



Black

END CAPS

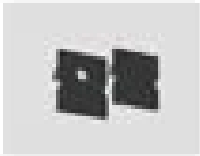

End cap with hole
End cap without hole

DIFFUSERS



PC diffused



Prismatic

ACCESSORIES



90° Horizontal connector



90° Vertical connector



180° Connector



Disposable cover





SOLO SU RICHIESTA

PROFILI PER CARTONGESSO



Types of installation:



74ALP110-S



Material: Extruded aluminum
Dimension: 65.4x28mm
Length: MAX 3m
Compatible with 12.5mm drywall

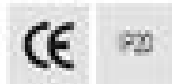

FINISH



Anod aluminum white Black

END CAPS

DIFFUSERS

ACCESSORIES



End cap with hole
End cap without hole

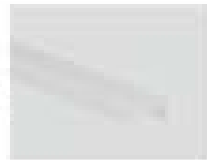

PC diffused



Disposable cover

Types of installation:



Material: Extruded aluminum
Dimension: 65.4x28mm
Length: MAX 6m
Compatible with 12.5mm drywall



74ALP110-R

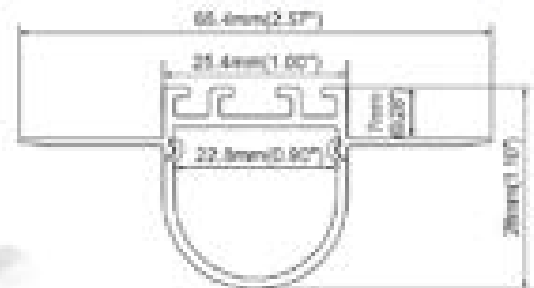

FINISH



Anod aluminum white Black

END CAPS

DIFFUSERS

ACCESSORIES



End cap with hole
End cap without hole

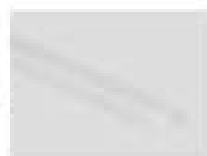

PC diffused

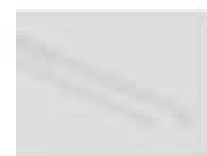

Disposable cover



SOLO SU RICHIESTA

PROFILI PER CARTONGESSO

Types of installation:



Material: Extruded aluminum
Dimension: 94.4x34mm
Length: MAX 3m
Compatible with 12.5mm drywall

74ALP126

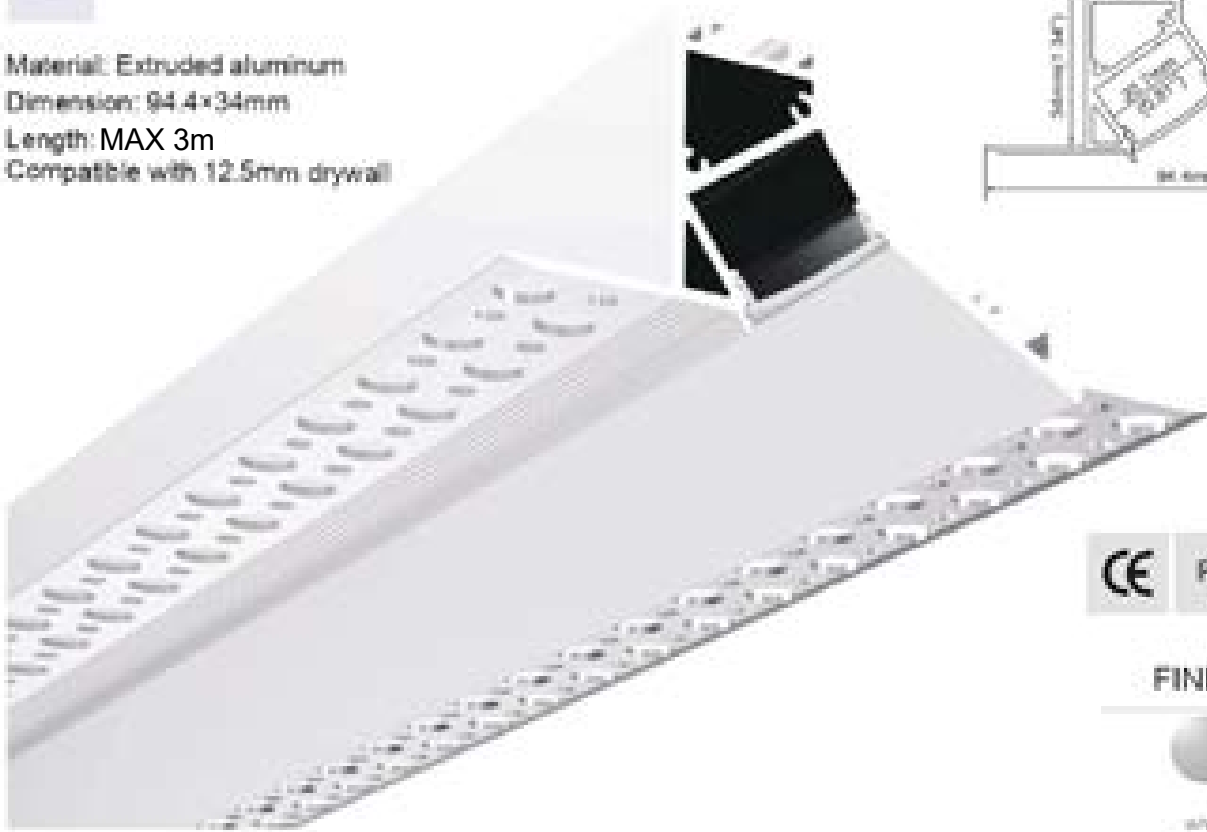
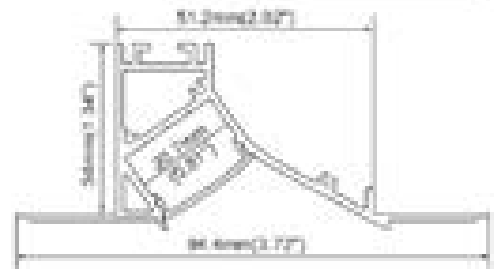

FINISH



white

END CAPS

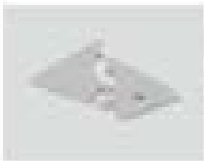

End cap with hole
End cap without hole

DIFFUSERS



PC diffused
PC semi clear

ACCESSORIES

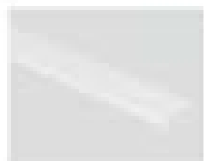

Disposable cover





SOLO SU RICHIESTA

PROFILI PER CARTONGESSO

Types of installation:



Material: Extruded aluminum
Dimension: 14.8x90.8mm
Length: MAX 3m
Compatible with 12.5mm drywall

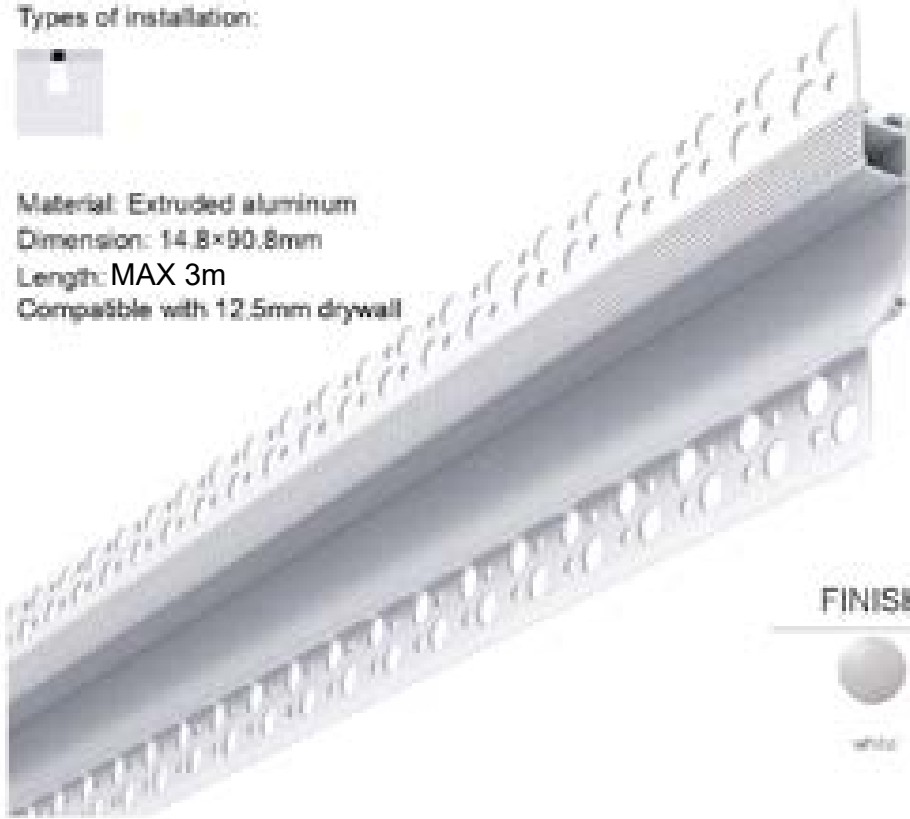

74ALP186



FINISH



white

R10 - R90
20° beam angle



R18 - R90
30° beam angle

END CAPS



End Caps

DIFFUSERS

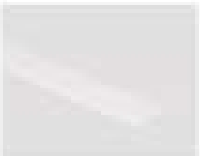

PC diffused

ACCESSORIES



90° Horizontal connector



90° Vertical connector



180° Connector

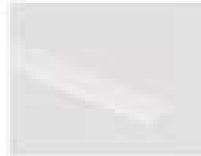

Disposable cover



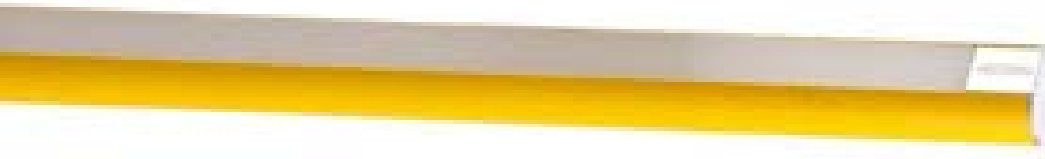
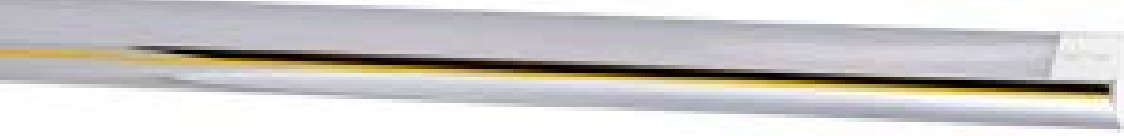
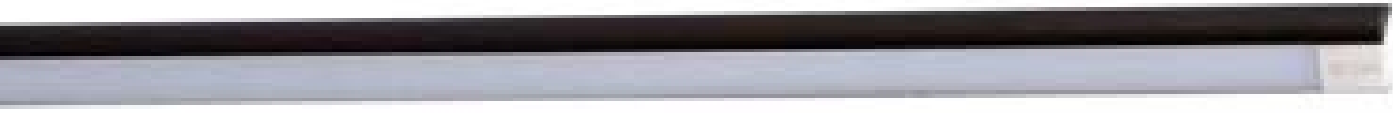
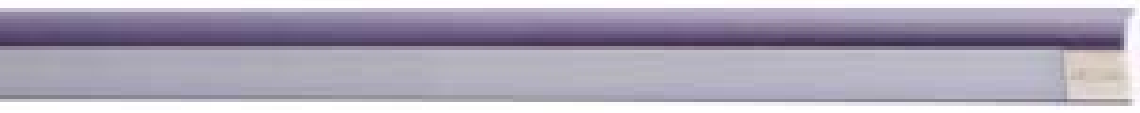
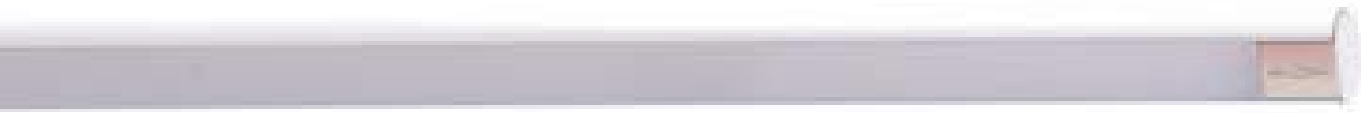

CILINDRO

CILINDRO

Colori e lenti

La struttura del **Cilindro** di Led4led è realizzata in alluminio ed è disponibile nelle finiture:

- alluminio naturale
- alluminio cromato
- verniciato a polveri nei colori standard neri e bianco
- verniciato a polveri nei colori a richiesta

Cilindro è disponibile in due versioni: con lenti opaline bianco latte oppure con lenti trasparenti a seconda delle necessità estetiche/funzionali.

Il **Cilindro** è adatto all'uso in molteplici uffici e applicazioni:

- Illuminazione cucine e bagni
- Illuminazione armadi e vetrine
- Illuminazione ad incasso e fissa installazione

lente bianco opale



lente trasparente



CILINDRO

74LC...



CILINDRO

Cilindro un brevetto tutta italiana!!!

La potenza luminosa led/metro varia a seconda delle necessità: da 5W, 9W, 12W e 17.6W. **Cilindro** è integrabile con sistema RGB. La tensione di funzionamento è di 12v. Temperatura colore bianco caldo da 3000/3500°K mentre in bianco naturale 4000/5000°K. **Cilindro** è fornito di cavo da 1.50 mt e necessita di un alimentatore (trasformatore) da 12v a corrente continua.

Dimensioni

Il profilo in alluminio è disponibile fino ad una lunghezza massima di 4 metri mentre la lente mono opalina raggiunge un massimo di 3 metri. Questa caratteristica offre una completa libertà di progettazione.

Cilindro NO LED Anod. Bianco/Colori Colore in richiesta

Codice 74LC

Cilindro_5W

Codice	Watt	IP	Colore
74LC5WMM	5W	40	Alluminio anodizzato
74LC5WNR	5W	40	Arancione
74LC5WRD	5W	40	Rosso
74LC5WB	5W	40	Bianco
74LC5WV	5W	40	Verde
74LC5WC	5W	40	Grigio
74LC5WN	5W	40	Nero
74LC5WCH	5W	40	Cromo

Cilindro_15W

Codice	Watt	IP	Colore
74LC15MM	15W	40	Alluminio anodizzato
74LC15NR	15W	40	Arancione
74LC15RD	15W	40	Rosso
74LC15B	15W	40	Bianco
74LC15V	15W	40	Verde
74LC15C	15W	40	Grigio
74LC15N	15W	40	Nero
74LC15CH	15W	40	Cromo

Cilindro_12W

Codice	Watt	IP	Colore
74LC12MM	12W	40	Alluminio anodizzato
74LC12NR	12W	40	Arancione
74LC12RD	12W	40	Rosso
74LC12B	12W	40	Bianco
74LC12V	12W	40	Verde
74LC12C	12W	40	Grigio
74LC12N	12W	40	Nero
74LC12CH	12W	40	Cromo

Cilindro_17W

Codice	Watt	IP	Colore
74LC17MM	17W	40	Alluminio anodizzato
74LC17NR	17W	40	Arancione
74LC17RD	17W	40	Rosso
74LC17B	17W	40	Bianco
74LC17V	17W	40	Verde
74LC17C	17W	40	Grigio
74LC17N	17W	40	Nero
74LC17CH	17W	40	Cromo

CILINDRO ACCESSORI



tappo di chiusura
acciaio

CILINDRO

Agganci

Cilindro è accessorato da vari tipi di agganci, a bussola, con pinze in alluminio cromato oppure con anelli in pvc bianco. Ogni tipologia di aggancio permette la direzionalità dell'illuminazione.

Applicazioni

Grazie a questa gamma di attacchi **Cilindro** viene impiegato in moltissime tipologie applicative come:

- illuminazione a sospensione
- applique, lampada da parete
- illuminazione per oggetti ed armadi

E non solo, **Cilindro** può essere inserito anche in forata.



ASOLA POLIPROPILENE
74LGRAPP



GRAFFA ALLUMINIO
74LGRAC



BUSSOLA
74LBU14D

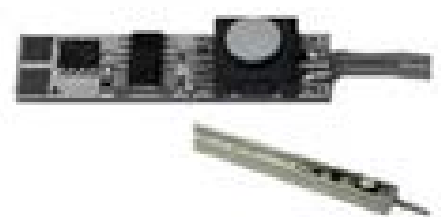

INTERRUTTORE ON/OFF
74APAR056AS

CILINDRO



CILINDRO



CILINDRO



